

DATA SHEET

PDI1394L11

1394 AV link layer controller

Preliminary specification

1996 Nov 06



PHILIPS

1394 AV link layer controller

PDI1394L11

1.0 FEATURES

- IEEE 1394–1995 Standard Link Layer Controller
- Hardware Support for the Proposed IEC1883 Standard of Digital Interface for Consumer Electronics
- Interfaces to any IEEE 1394–1995 Physical Layer Interfaces
- 5V Tolerant I/Os
- Single 3.3V supply voltage

2.0 DESCRIPTION

The PDI1394L11, Philips Semiconductors 1394 Audio/Video (AV) Link Layer Controller, is an IEEE 1394–1995 compliant link layer controller featuring an embedded AV layer interface. The AV layer is designed to pack and un-pack application data packets for transmission over an IEEE 1394 bus using isochronous data transfers.

The application data is packetized according to the proposed IEC 1883 Specification of Digital Interface for Consumer Electronic Audio/Video Equipment. The AV layer interface is a byte-wide port capable of accommodating various MPEG–2 and DVC codecs. An 80C51 or MC68XX compatible byte-wide host interface is provided for internal register configuration as well as performing asynchronous data transfers.

The PDI1394L11 is powered by a single 3.3V power supply and the inputs and outputs are 5V tolerant. It is available in the PQFP80 package.

3.0 QUICK REFERENCE DATA

GND = 0V; $T_{amb} = 25^{\circ}\text{C}$; $t_r = t_f = 2.5 \text{ ns}$

SYMBOL	PARAMETER	CONDITIONS	MIN	TYP	MAX	UNIT
V_{DD}	Functional supply voltage range		3.0	3.3	3.6	V
I_{DD}	Total supply current @ $V_{DD}=3.3\text{V}$			TBD		mA
SCLK	Device clock		0	49.978	50	MHz

4.0 ORDERING INFORMATION

PACKAGES	TEMPERATURE RANGE	OUTSIDE NORTH AMERICA	NORTH AMERICA	PKG. DWG. #
80-pin plastic PQF80	0°C to +70°C	PDI1394L11 D	PDI1394L11 D	SOT318–2

1394 AV link layer controller

PDI1394L11

5.0 PIN CONFIGURATION

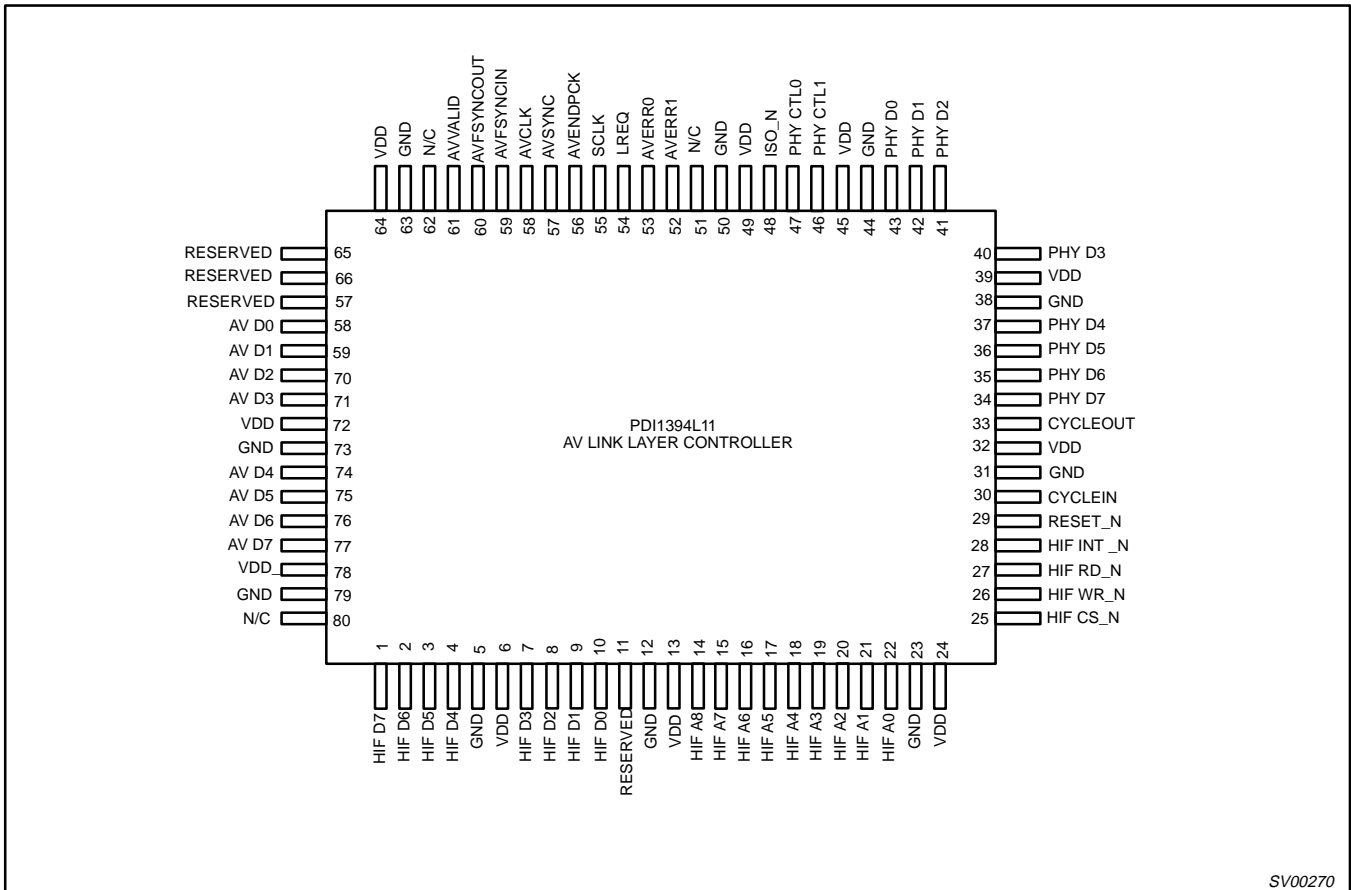

SV00270

1394 AV link layer controller

PDI1394L11

6.0 FUNCTIONAL DIAGRAM

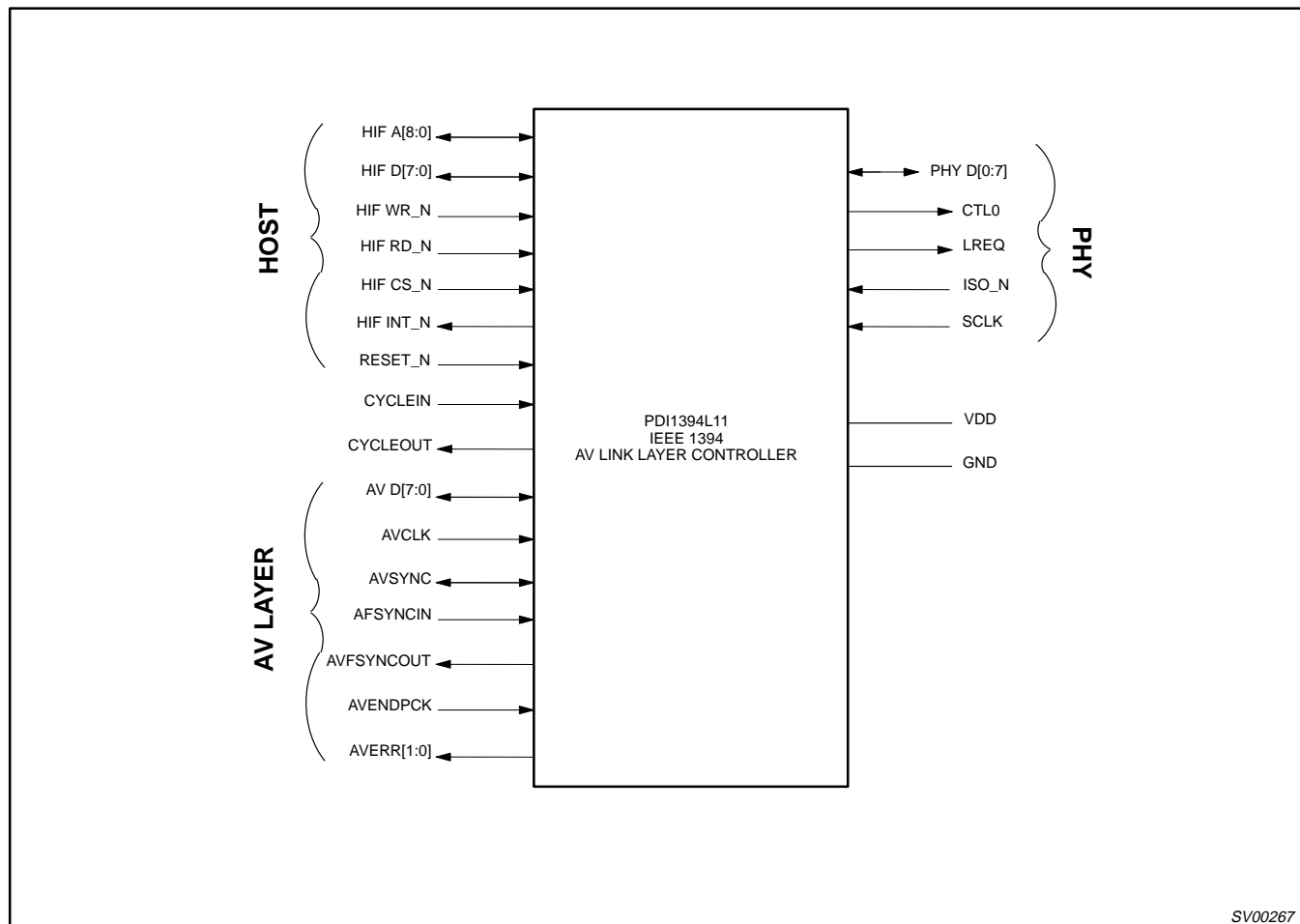

SV00267

1394 AV link layer controller

PDI1394L11

7.0 INTERNAL BLOCK DIAGRAM

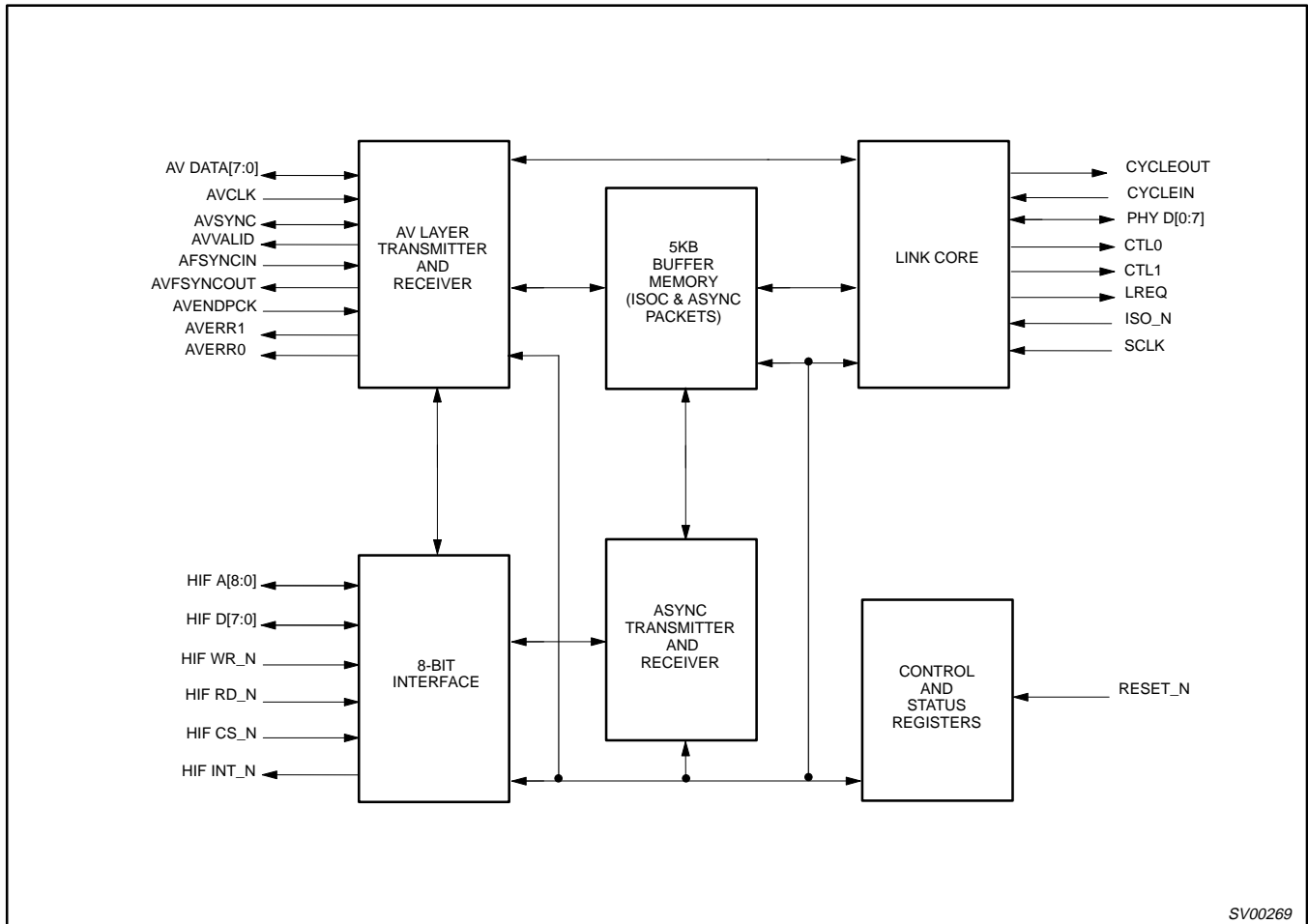

SV00269

8.0 APPLICATION DIAGRAM

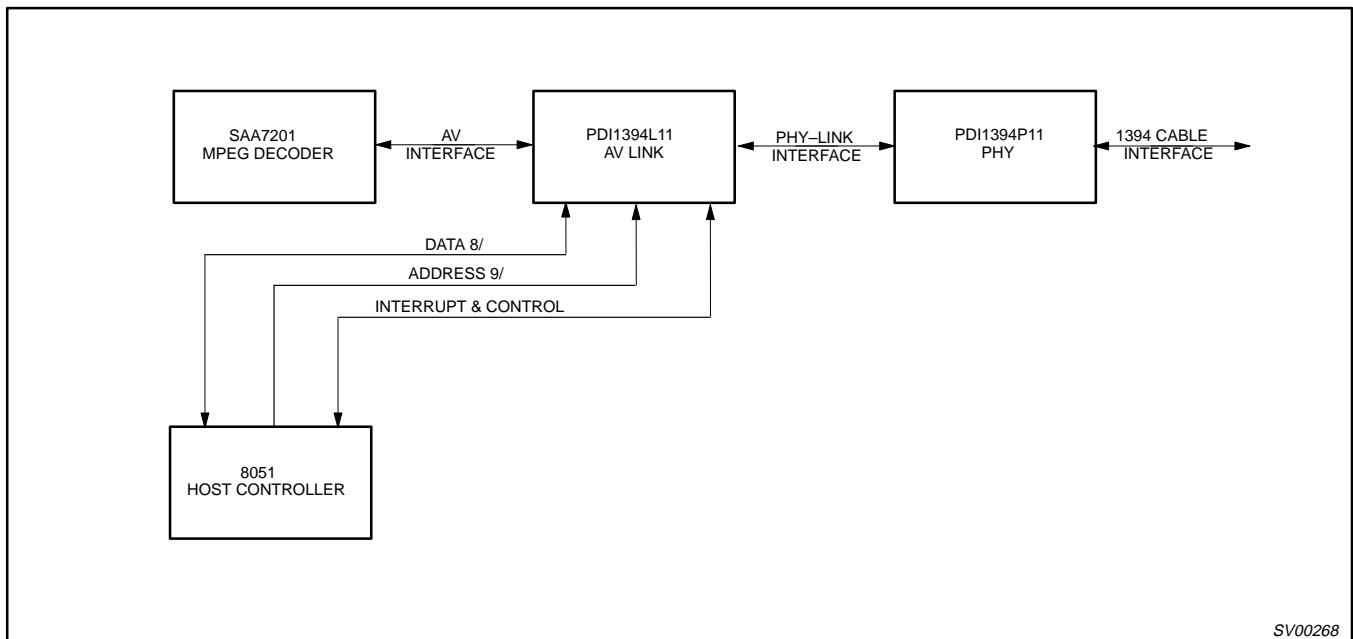

SV00268

1394 AV link layer controller

PDI1394L11

9.0 PIN DESCRIPTION

9.1 Host Interface

PIN No.	PIN SYMBOL	I/O	NAME AND FUNCTION
14, 15, 16, 17, 18, 19, 20, 21, 22	HIF A[8:0]	I	Host Interface Address 0 through 8. Provides the host with a byte wide interface to internal registers. See description of Host Interface for addressing rules.
1, 2, 3, 4, 7, 8, 9, 10	HIF D[7:0]	I/O	Host Interface Data 7 (MSB) through 0. Byte wide data path to internal registers.
26	HIF WR_N	I	Write enable. When asserted (LOW) in conjunction with HIF CS_N, a write to the PDI1394L11 internal registers is requested.
27	HIF RD_N	I	Read enable. When asserted (LOW) in conjunction with HIF CS_N, a read of the PDI1394L11 internal registers is requested.
25	HIF CS_N	I	Chip Select (active LOW). Host bus control signal to enable access to the FIFO and control and status registers.
28	HIF INT_N	O	Interrupt (active low). Indicates a interrupt internal to the PDI1394L11. Read the General Interrupt Register for more information.
29	RESET_N	I	Reset (active low). The asynchronous master reset to the PDI1394L11.
30	CYCLEIN	I	Provides the capability to supply an external cycle timer signal for the beginning of 1394 bus cycles.
33	CYCLEOUT	O	Reproduces the 8kHz cycle clock of the cycle master.
6, 13, 24, 32, 39, 45, 49, 64, 72, 78	V _{DD}		3.0V 0.3V power supply
5, 12, 23, 31, 38, 44, 50, 63, 73, 79	GND		Ground reference

9.2 AV Interface

PIN No.	PIN SYMBOL	I/O	NAME AND FUNCTION
77, 76, 75, 74, 71, 70, 69, 68	AVDATA[7:0]	I/O	Audio/Video Data 7 (MSB) through 0. Byte-wide interface to the AV layer.
58	AVCLK	I	External application clock. Rising edge active.
57	AVSYNC	I/O	Start of packet indicator.
59	AVFSYNCIN	I	Frame sync input, rising edge active.
60	AVFSYNCOUT	O	Frame sync output
56	AVENDPCK	I	End of application packet indication from data source. Indicates input packet is not multiple of DBS.
61	AVVALID	I/O	Indicates data on AVDATA is valid
53	AVERR0	O	CRC error, indicates bus packet containing AVDATA had a CRC error.
52	AVERR1	O	Sequence Error. Indicates at least one source packet was lost before the current source packet.

9.3 Phy Interface

PIN No.	PIN SYMBOL	I/O	NAME AND FUNCTION
34, 35, 36, 37, 40, 41, 42, 43	PHY D[7:0]	I/O	Data 0 (MSB) through 7 (NOTE: To preserve compatibility to the specified Link-Phy interface of the IEEE 1394-1995 specification, bit 0 is the most significant bit). Data is expected on D[0:1] for 100Mb/s, D[0:3] for 200Mb/s, and D[0:7] for 400Mb/s. See 1394 Specification for more information.
46, 47	PHY CTL[1:0]	I/O	Control Lines between Link and Phy. See 1394 Specification for more information.
48	ISO_N	I	Isolation barrier. This terminal is asserted (low) when an isolation barrier is present. See 1394 Specification for more information.
54	LREQ	O	Link Request. Bus request to access the PHY. See 1394 Specification for more information.
55	SCLK	I	System clock. 49.152MHz input from the PHY. Used to generate a 24.576MHz clock.

9.4 Other Pins

PIN No.	PIN SYMBOL	I/O	NAME AND FUNCTION
65, 66, 67	RESERVED	NA	These pins are reserved for factory testing. For normal operation they should be connected to ground.
11, 51, 62, 80	N/C	NA	These pins are should be not be connected or terminated.

1394 AV link layer controller

PDI1394L11

10.0 RECOMMENDED OPERATING CONDITIONS

SYMBOL	PARAMETER	CONDITIONS	LIMITS		UNIT
			MIN.	MAX.	
V _{CC}	DC supply voltage		3.0	3.6	V
V _I	Input voltage		0	5	V
V _{IH}	High-level input voltage		2.0		V
V _{IL}	Low-level input voltage			0.8	V
I _{OH}	High-level output current			8	mA
I _{OL}	Low-level output current			-8	mA
dT/dV	Input transition rise or fall time		0	20	ns/V
T _{amb}	Operating ambient temperature range		0	+70	°C
SCLK	System clock		49.1519	49.1521	MHz
AVCLK	AV interface clock				

11.0 ABSOLUTE MAXIMUM RATINGS^{1, 2}

In accordance with the Absolute Maximum Rating System (IEC 134). Voltages are referenced to GND (ground = 0V)

SYMBOL	PARAMETER	CONDITIONS	LIMITS		UNIT
			MIN	MAX	
V _{DD}	DC supply voltage		-0.5	+4.6	V
I _{IK}	DC input diode current		-	-50	mA
V _I	DC input voltage		-0.5	+5.5	V
I _{OK}	DC output diode current		-	50	mA
V _O	DC output voltage		-0.5	V _{DD} + 0.5	V
I _O	DC output source or sink current		-	50	mA
I _{GND} , I _{CC}	DC V _{CC} or GND current		-	150	mA
T _{stg}	Storage temperature range		-60	150	°C
T _{amb}	Operating ambient temperature		0	70	°C
P _{tot}	Power dissipation per package			TBD	W

NOTES:

- Stresses beyond those listed may cause permanent damage to the device. These are stress ratings only and functional operation of the device at these or any other conditions beyond those indicated under "recommended operating conditions" is not implied. Exposure to absolute-maximum-rated conditions for extended periods may affect device reliability.
- The performance capability of a high-performance integrated circuit in conjunction with its thermal environment can create junction temperatures which are detrimental to reliability. The maximum junction temperature of this integrated circuit should not exceed 150°C.

11.1 Buffer Memory Sizes

BUFFER MEMORY	SIZE (Quadlets)
Asynchronous Receive Transaction Response FIFO	64
Asynchronous Receive Transaction Request FIFO	64
Asynchronous Transmit Transaction Response FIFO	64
Asynchronous Transmit Transaction Request FIFO	64
AV Transmit/Receive Buffer	1024

1394 AV link layer controller

PDI1394L11

12.0 FUNCTIONAL DESCRIPTION

12.1 Overview

The PDI1394L11 is an IEEE 1394–1995 compliant link layer controller. It provides a direct interface between a 1394 bus and various MPEG–2 and DVC codecs. Via this interface, the AV Link maps and un–maps these AV datastreams from the these codecs onto 1394 isochronous bus packets. The AV Link also provides an 8051 / MC68XX compatible interface for an attached host controller. Through the host interface port, the host controller can configure the AV layer for transmission or reception of AV datastreams. The host interface port also allows the host controller to transmit and receive 1394 asynchronous data packets.

12.2 AV interface and AV layer

The AV interface and AV layer allow AV packets to be transmitted from one node to another. The AV transmitter and receiver within the AV layer perform all the functions required to pack and unpack AV packet data for transfer over a 1394 network. Once the AV layer is properly configured for operation, no host controller service should be required. The host controller will have to intervene only in the case of an AV transmit/receive buffer overrun, or other error event in the AV layer. The operation of the AV layer is half–duplex, i.e., an AV layer can either receive or transmit AV packets at a particular time.

12.2.1 The AV Interface

The AV Link provides an 8 bit data path to the AV layer. The 8 bit data path is designed with associated clock and control signals to be compatible with various MPEG–2 and DVC codecs.

When properly configured, the AV interface port will time stamp and buffer the incoming AV packets. The AV packet data is stored in the embedded memory buffer, along with its time stamp information. During the next available isochronous bus cycle, the AV layer creates an isochronous bus packet with the appropriate CIP header and AV data. The size and configuration of isochronous data packet payload transmitted is determined by the AV layer's configuration registers accessible through the host interface.

Once configured, the AV interface port waits for the assertion of AVVALID and AVSYNC as well as a valid AVCLK. AVSYNC is a pulse that is aligned with the leading edge of AVCLK and the first byte of data on AVDATA[7:0]. Its duration is one AVCLK cycle. AVSYNC signals the AV layer that the transfer of an AV packet has begun. At the time that AVSYNC is asserted, the AV layer stores the current time stamp in the buffer memory. This time stamp is transmitted, as part of the standard packet header, to signal the receiver at what time to provide the AV packet for output. As long as AVVALID is asserted, the data byte data present on AV DATA[7:0] at the active edge of AVCLK will be clocked into the AV layer for processing.

At the end of the AV data packet, assertion of AVENDPCK, for one clock, will signal the AV layer that the packet is complete. This signal is usually used when the AV packet does not fulfill the AV packet size used in the AV layer configuration.

12.2.2 IEC1883

The PDI1394L11 is specifically designed to support the proposed IEC1883 Specifications of Digital Interface for Consumer Electronic Audio/Video Equipment. The IEC specification defines a scheme for mapping various types of AV datastreams onto 1394 isochronous data packets. The specification also defines a software protocol for managing isochronous channels in a 1394 network called Function Control Protocol (FCP) and Connection Management Procedures (CMP).

The mapping of AV datastreams onto 1394 isochronous packets is handled automatically by the AV Link. A special 'AV layer' is included in the AV Link to manage the packing and unpacking of AV datastreams onto isochronous packets. Some features of the AV layer are automatic time–stamping of incoming packets, buffer memory management and automatic construction of 1394 isochronous packets. Each 1394 isochronous packet generated by the AV layer contains a special header holding information specific to the packing parameters used to make the packet. These special headers are called Common Isochronous Packet (CIP) headers.

12.2.3 CIP Headers

A feature of the IEC1883 specification is the definition of Common Isochronous Packet (CIP) headers. These CIP headers contain information about the source and type of datastream mapped onto the isochronous packets.

The AV Layer supports the use of CIP headers. CIP headers are added to transmitted isochronous data packets at the AV data source. When receiving isochronous data packets, the AV layer automatically analyzes their CIP headers. The analysis of the CIP headers determines the method the AV layer uses to unpack the AV data from the isochronous data packets.

The information contained in the CIP headers is accessible via registers in the host interface.

(See proposed IEC1883 "Specifications of Digital Interface for Consumer Electronic Audio/Video Equipment" December 1995, Section 6 for more details on CIP headers).

1394 AV link layer controller

PDI1394L11

12.3 Host interface Port

The PDI1394L11 Host interface provides an 8 bit (byte-wide) data path, 9 address lines, and associated control lines to access the AV Link Controller's 32-bit internal registers. The interfacing scheme allows the byte-wide data path to access the internal registers in 4 accesses.

12.3.1 Using the Host Interface

The PDI1394L11 Host interface provides an 8 bit (byte-wide) data path, 9 address lines, and assorted control lines to access the AV Link Controller's 32-bit internal registers. The interfacing scheme allows the byte-wide data path to access the internal registers in 4 accesses.

12.3.2 Addressing Scheme

The PDI1394L11 contains twenty-nine (29) 32-bit internal registers. These registers are accessible through the 8-bit host interface data path using a quadlet-to-byte multiplexing scheme. The multiplexing scheme involves reading or writing the contents of an internal register to a shadow register. The shadow register provides the host interface with access to the internal register's contents, one byte at a time. The host interface contains a 32-bit shadow register that is used to temporarily store internal register data during reads or writes. Host interface Address bit 8 (HIF ADDR8) is used to signal internal logic to either transfer the contents of an internal 32-bit register to the host interface shadow register, in the case of a read, or transfer the contents of the host interface shadow register to an internal 32-bit register, in the case of a write. Reading the shadow register with HIF A8=1 is called a read with update, writing to the shadow register with HIF A8=1 is called a write with update. Successive reads to the other 3 bytes of the 32-bit register should not have HIF A8 set. An example of accessing the General Control Register is shown in Figure 1.

The host interface uses 9 address bits to form the byte-wide addresses. Each internal 32-bit register has a base address that points to the lowest order byte in the register. The next three addresses (base address+1, +2, and +3) are the next higher order bytes of the 32-bit internal register. Note that base address+0 retrieves or writes the most significant byte, bits 31-24, of a 32-bit register; base address+1 retrieves or writes the next most significant byte, bits 23-16 of a 32-bit register; and so on.

```

*****
This code segment shows how to read the General Control Register, located at address 0x004 and move its contents to an array
located at TEMP.
*****

MOVE 0x104, TEMP           Gets contents of GENCTL bits 31-24, low byte, and moves it to TEMP
MOVE 0x005, TEMP+1        Gets the next byte of GENCTL bits 23-16 and moves it to TEMP+1
MOVE 0x006, TEMP+2        Gets the 3rd byte of GENCTL bits 15-8 and moves it to TEMP+2
MOVE 0x007, TEMP+3        Gets the last byte of GENCTL bits 7-0 and moves it to TEMP+3

*****
This code segment shows how to write the General Control Register, located at address 0x004 with the contents of an array
located at TEMP.
*****

MOVE TEMP, 0x004           Moves TEMP to the first byte of GENCTL, bits 31-24
MOVE TEMP+1, 0x005         Moves TEMP+1 to the second byte of GENCTL, bits 23-16
MOVE TEMP+2, 0x006         Moves TEMP+2 to the 3rd byte of GENCTL, bits 15-8
MOVE TEMP+3, 0x107         Moves TEMP+3 to the last byte of GENCTL, bits 7-0, and performs the write with update
    
```

SV00266

Figure 1. General Control Register Read/Write Code Segments

1394 AV link layer controller

PDI1394L11

12.4 The Asynchronous Packet Interface

The PDI1394L11 provides an interface to asynchronous data packets through the registers in the host interface. The format of the asynchronous packets is specified in the following sections.

12.4.1 Reading an Asynchronous Packet

Upon reception of a packet, the packet data is stored in the appropriate receive FIFO, either the Request or Response FIFO. The location of the packet is indicated by either the RXRQA or RXRPA status bit being set in the Asynchronous RX/TX Control 2 (ASY_CR2) register. The packet is transferred out of the FIFO by successive reads of the Asynchronous Receive Request (RX_RQ) or Asynchronous Receive Response (RX_RP) register. The end of the packet (the last quadlet) is indicated by either the RXRPL or RXRQL bit set in ASY_CR2. Continuing to try to read the FIFO after the last quadlet has been read will result in a queue read error indicated by the either RXRQE bit or RXRPE bit being set in Asynchronous RX/TX Control 2 (ASY_CR2) register.

12.4.2 Writing an Asynchronous Packet

An asynchronous packet intended for transmission is first stored in the appropriate Transmitter FIFO. Once writing to the FIFO is complete, the link layer controller arbitrates for the bus to transmit the packet.

To generate an asynchronous packet, the first and next to last quadlets of the packet must be written to the Asynchronous Transmit Request Nextone (TX_RQ_NEXT) register, for request type packets, or the Asynchronous Transmit Response Next (TX_RP_NEXT) register, for response type packets. The last quadlet of the packet is written to the Asynchronous Transmit Request Last (TX_RQ_LAST) register, for request type packets, or the Asynchronous Transmit Response Last (TX_RP_LAST) register, for response type packets. After writing the last quadlet, the packet is automatically queued by the AVlink layer controller for transmission over the bus.

12.5 Link Packet Data Formats

The data formats for transmission and reception of data are shown below. The transmit format describes the expected organization for data presented to the link at the asynchronous transmit, physical response, or isochronous transmit FIFO interfaces. The receive format of data link presents at the receive FIFO interface.

12.5.1 Asynchronous Transmit

There are four basic formats for asynchronous data to be transmitted:

1. no-data packets (used for quadlet read requests and all write responses)
2. quadlet packets (used for quadlet write requests, quadlet read responses, and block read requests)
3. block packets (used for lock requests and responses, block write requests, and block read responses)
4. unformatted data.

12.5.1.1 No-data Transmit

The no-data transmit format is shown in Table 1. The first quadlet contains packet control information. The second and third quadlets contain 16-bit destination ID and either the 48-bit, quadlet aligned destination offset(for requests) or the response code (for responses).

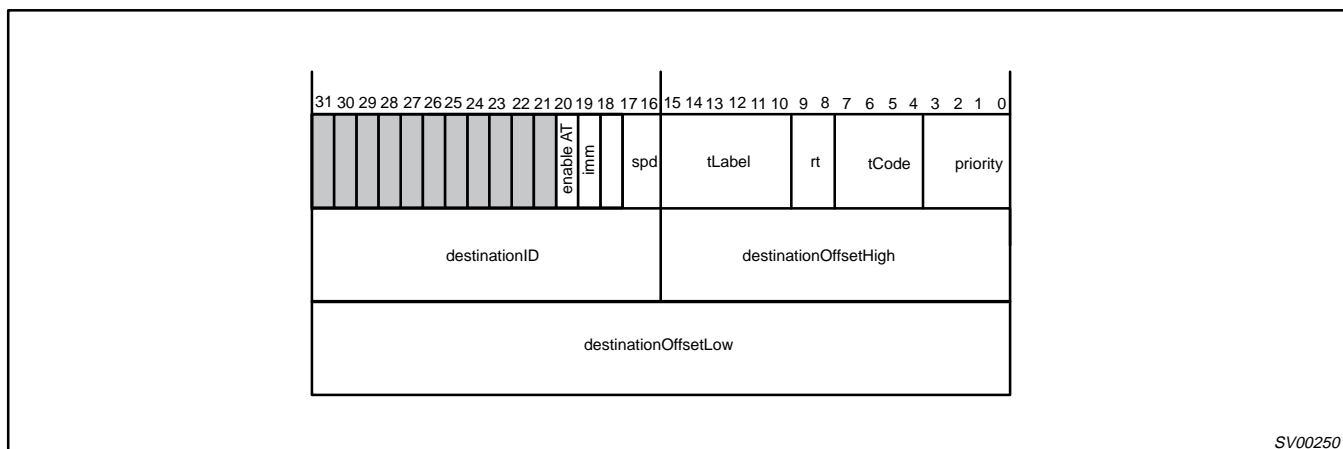

SV00250

Figure 2. Quadlet Read Request Transmit Format

1394 AV link layer controller

PDI1394L11

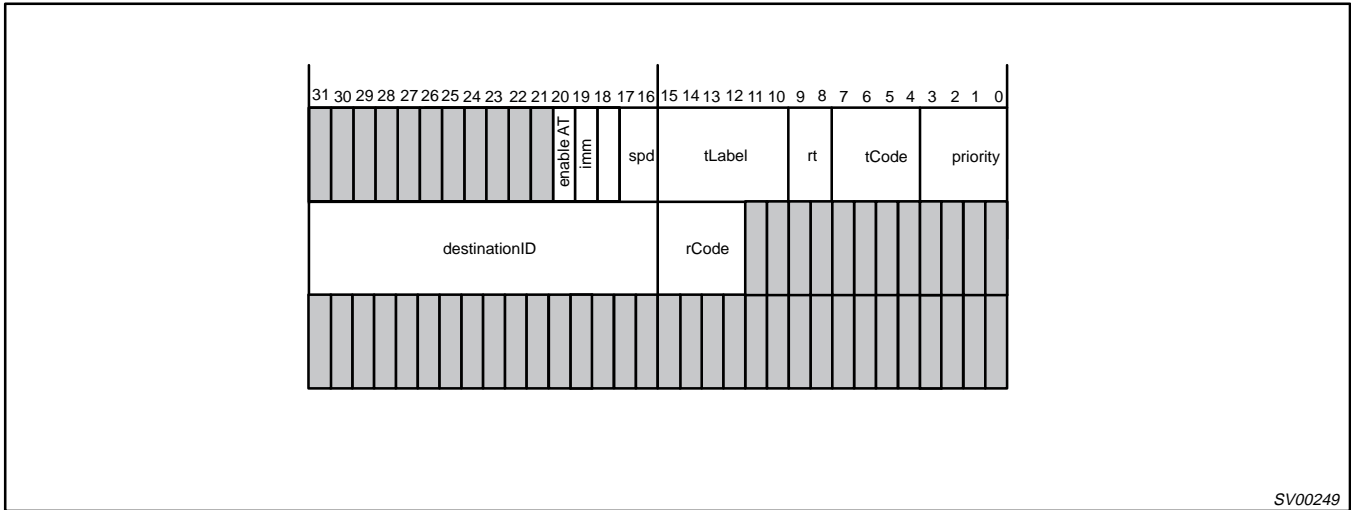

Figure 3. Write Response Transmit Format

SV00249

Table 1. No-Data Transmit Format

Field Name	Description
enableAT	Re-enable asynchronous transmit operation. After a bus reset, all asynchronous transmit packets are flushed until a packet header with this bit is set is presented. Important: this bit should only be set for a single packet after a bus reset is detected. Normally this bit should be cleared, allowing the link core to flush queued packets that may no longer be correctly addressed after a bus reset.
imm	Always set to \$0'.
spd	This field indicates the speed at which this packet is to be sent. 00=100 Mbs, 01=200 Mbs, and 10=400 Mbs. 11 = undefined
tLABEL	This field is the transaction label, which is used to pair up a response packet with its corresponding request packet.
rt	The retry code for this packet. 00=retry 1, 01=retryX, 10=retryA, 11=retryB
tCode	The transaction code for this packet.
Priority	The priority level for this packet. Any non-zero value directs the transmitter to use priority arbitration for this packet.
DestinationID	This is the concatenation of the 10-bit bus address and the 6-bit node number for the destination of this packet.
DestinationOffsetHigh DestinationOffsetLow	The concatenation of these two field addresses a quadlet in the destination node's address space. This address must be quadlet-aligned (modulo 4).
RCode	Response code for write response packet.

1394 AV link layer controller

PDI1394L11

12.5.1.2 Quadlet Transmit

Three quadlet transmit formats are shown below. In these figures: The first quadlet contains packet control information. The second and third quadlets contain 16-bit destination ID and either the 48-bit quadlet-aligned destination offset (for requests) or the response code (for responses).

The fourth quadlet contains the quadlet data for read response and write quadlet request formats, or the upper 16 bits contain the data length for the block read request format.

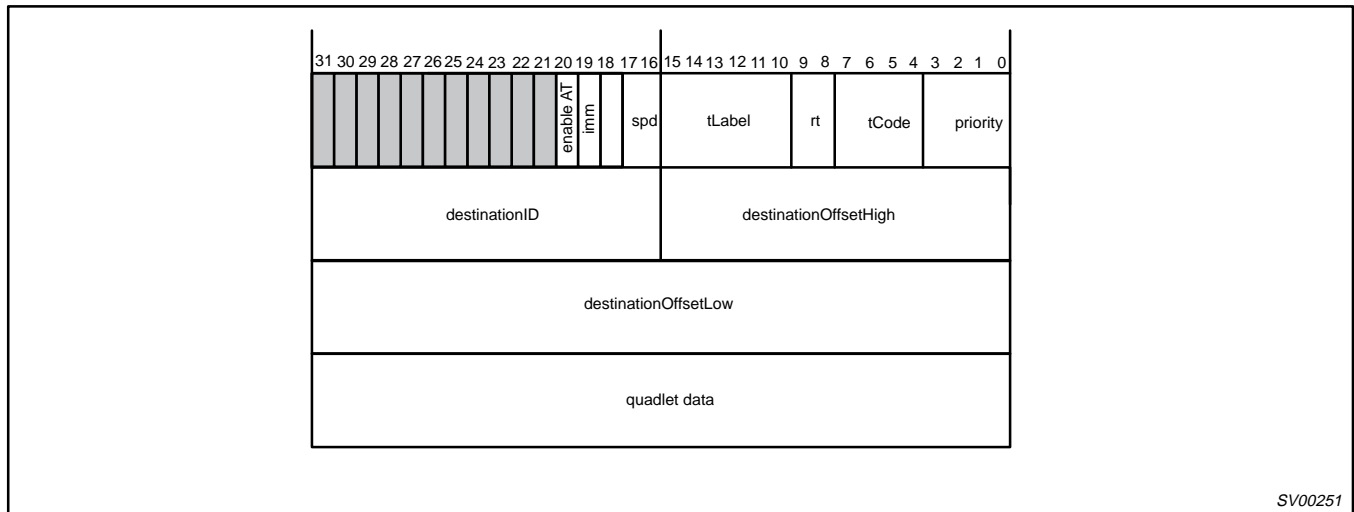

Figure 4. Quadlet Write Request Transmit Format

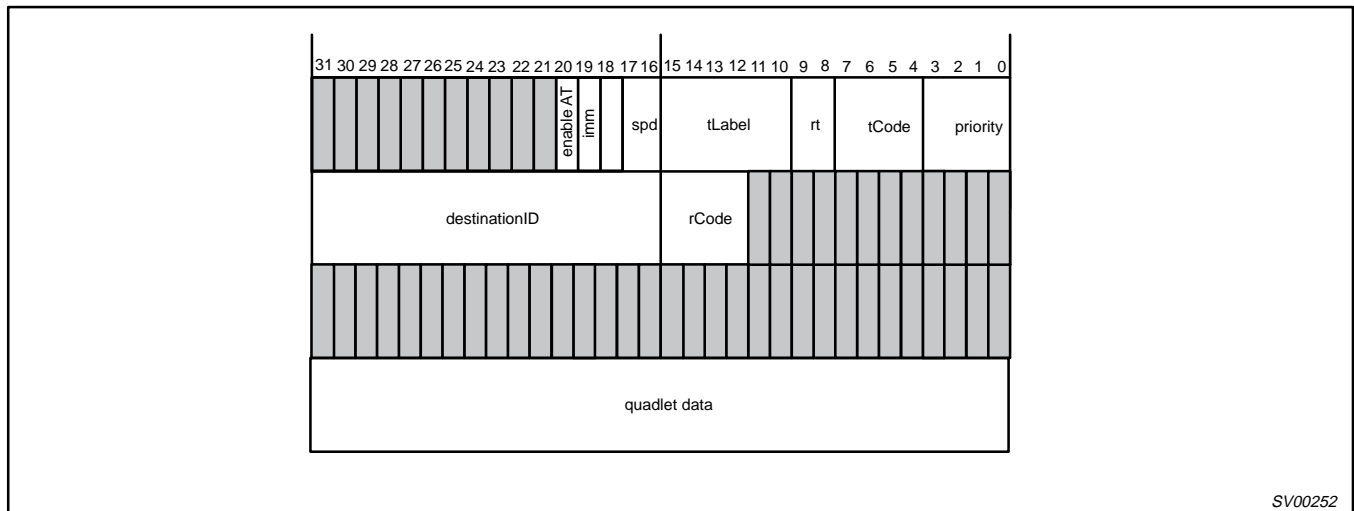
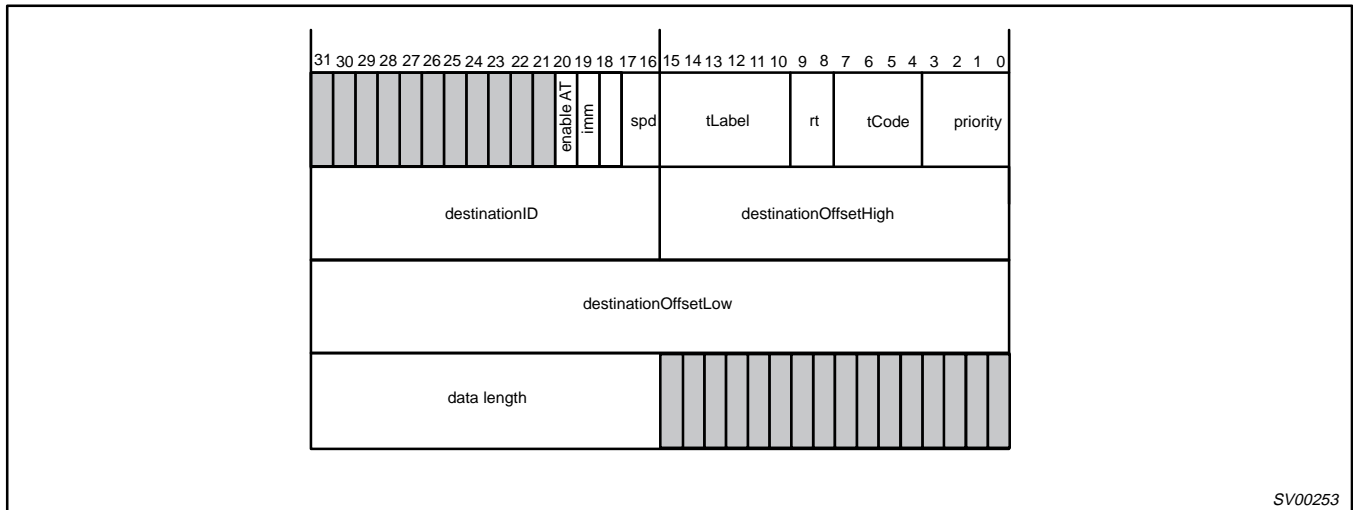

Figure 5. Quadlet Read Request Transmit Format

1394 AV link layer controller

PDI1394L11



SV00253

Figure 6. Block Read Request Transmit Format

Table 2. Quadlet Transmit Fields

Field Name	Description
enableAT, imm, spd, tLabel, rt, tCode, priority, destinationID, destinationOffsetHigh, destinationOffsetLow, rCode	See Table 1
Quadlet data	For quadlets write requests and quadlet read responses, this field holds the data to be transferred
Data length	The number of bytes requested in a block read request

12.5.1.3 Block Transmit

The block transmit format is shown below, this is the generic format for reads and writes. The first quadlet contains packet control information. The second and third quadlets contain the 16-bit destination node ID and either the 48-bit destination offset (for requests) or the response code and reserved data (for responses). The fourth quadlet contains the length of the data field and the extended transaction code (all zeros except for lock transaction). The block data, if any, follows the extended code.

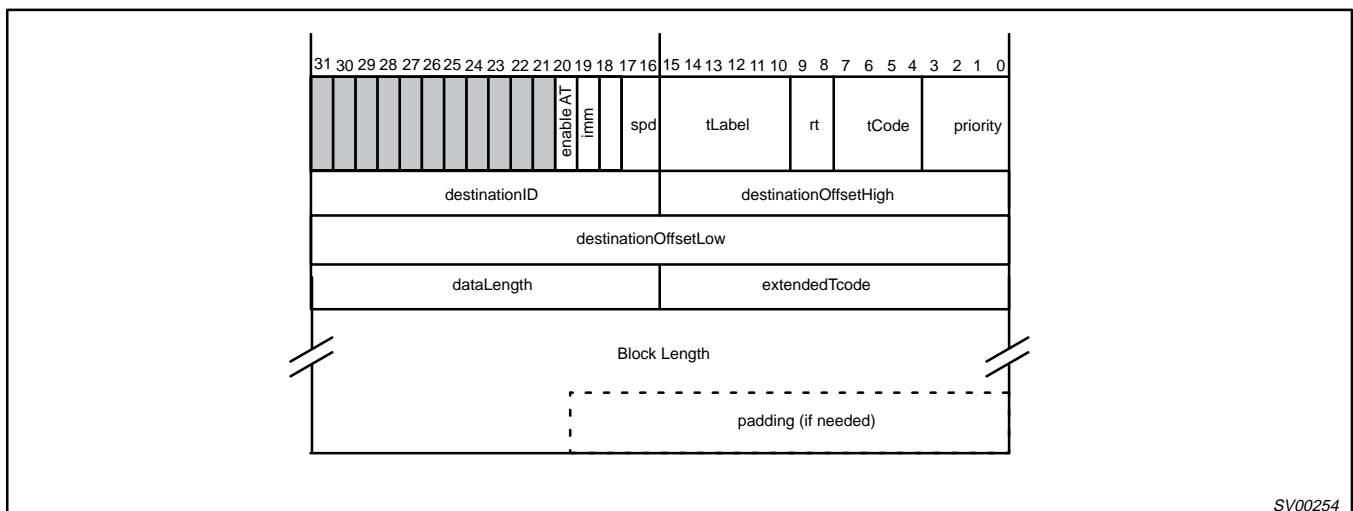

SV00254

Figure 7. Block Transmit Format

1394 AV link layer controller

PDI1394L11

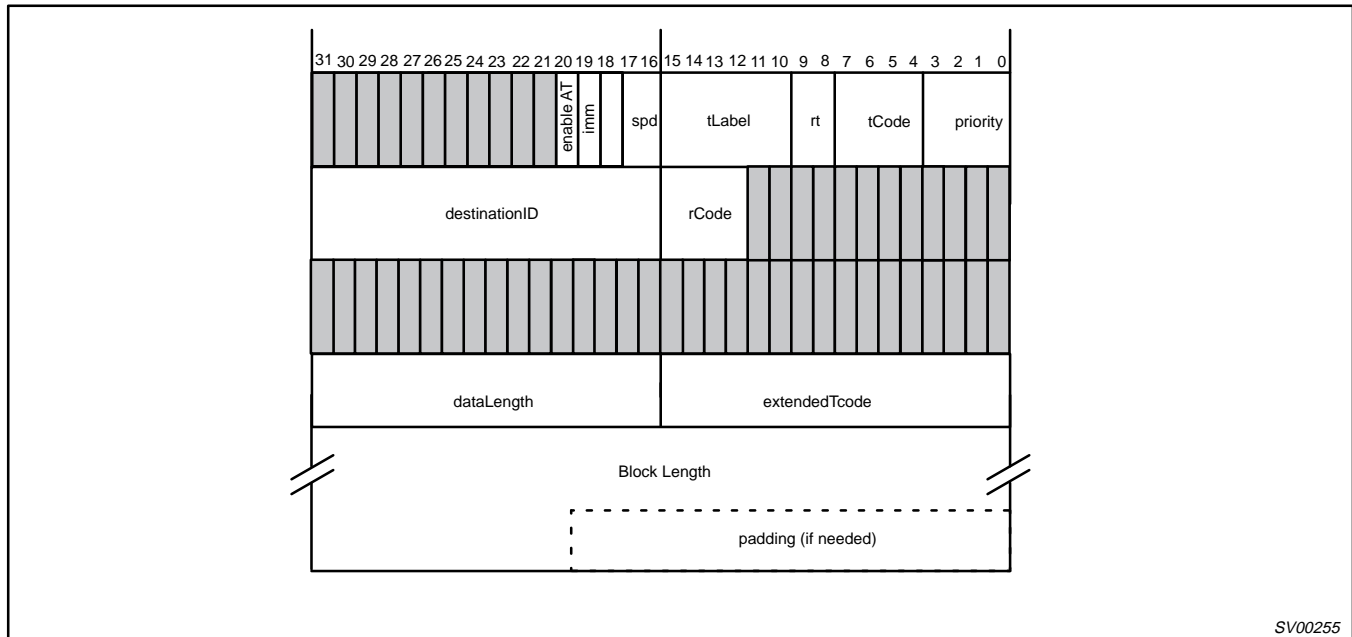

Figure 8. Block Read or Lock Response Transmit Format

SV00255

Table 3. Block Transmit Field

Field Name	Description
enableAT, imm, spd, tLabel, rt, tCode, priority, destinationID, destinationOffsetHigh, destinationOffsetLow, rCode	See Table 2.
dataLength	The number of bytes of data to be transmitted in this packet
extendedTcode	The tCode indicates a lock transaction, this specifies the actual lock action to be performed with the data in this packet.
block data	The data to be sent. If dataLength=0, no data should be written into the FIFO for this field. Regardless of the destination or source alignment of the data, the first byte of the block must appear in the high order byte of the first quadlet.
padding	If the dataLength mod 4 is not zero, then zero-value bytes are added onto the end of the packet to guarantee that a whole number of quadlets is sent.

1394 AV link layer controller

PDI1394L11

12.5.1.4 Unformatted Transmit

The unformatted transmit format is shown in Figure 9. The first quadlet contains packet control information. The remaining quadlets contain data that is transmitted without any formatting on the bus. No CRC is appended on the packet, nor is any data in the first quadlet sent. This is used to send PHY configuration and Link-on packets. Note that the bit-inverted check quadlet must be included in the FIFO since the AV Link core will not generate it.

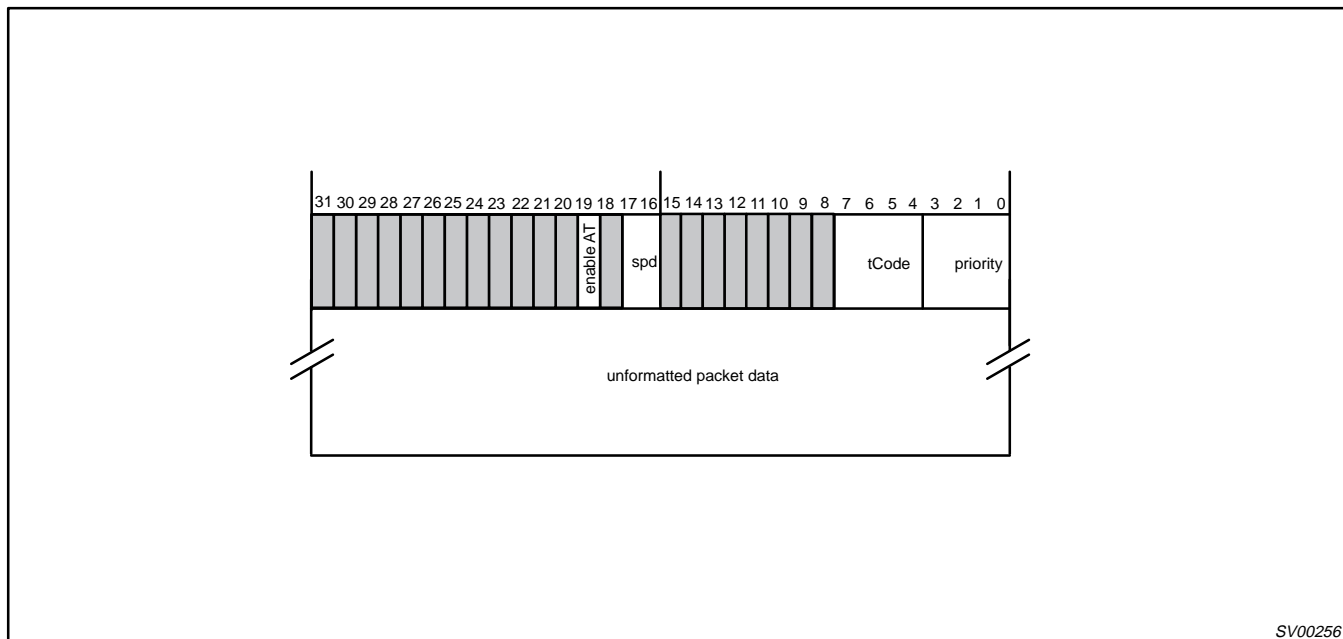

Figure 9. Unformatted Transmit Format

12.5.2 Asynchronous Receive

There are four basic formats for asynchronous data to be received:

1. no-data packets (used for quadlet read requests and all write responses)
2. quadlet packets (used for quadlet write requests, quadlet read responses, and block read requests),
3. block packets (used for lock requests and responses, block write requests, and block read responses),
4. self-ID data. The names and descriptions of the fields in the received data are given in Table 4.

1394 AV link layer controller

PDI1394L11

Table 4. Asynchronous Receive Fields

Field Name	Description
destinationID	This field is the concatenation of busNumbers (or all ones for "local bus" and nodeNumbers or all ones for broadcast) for this node.
tLabel	This field is the transaction label, which is used to pair up a response packet with its corresponding request packet.
rt	The retry code for this packet. 00=retry1, 01=retryX, 10=retryA, 11=retryB.
tCode	The transaction code for this packet. In this case 0xE (HEX, E)
priority	The priority level for this packet.
sourceID	This is the node ID of the sender of this packet.
destinationOffsetHigh, destinationOffsetLow	The concatenation of these two field addresses a quadlet in this node's address space. This address must be quadlet-aligned (modulo 4).
rCode	Response code for response packets.
quadlet data	For quadlet write requests and quadlet read responses, this field holds the data received.
dataLength	The number of bytes of data to be received in a block packet.
extendedTCode	If the tCode indicates a lock transaction, this specifies the actual lock action to be performed with the data in this packet.
block data	The data received. If dataLength=0, no data will be written into the FIFO for this field. Regardless of the destination or source alignment of the data, the first byte of the block will appear in the high order byte of the first quadlet.
padding	If the dataLength mod 4 is not zero, then zero-value bytes are added onto the end of the packet to guarantee that a whole number of quadlets is sent.

12.5.2.1 No-Data Receive

The no-data receive formats are shown below. The first quadlet contains the destination node ID and the rest of the packet header. The second and third quadlet contain 16-bit source ID and either the 48-bit, quadlet-aligned destination offset (for requests) or the response code (for responses). The last quadlet contains packet reception status.

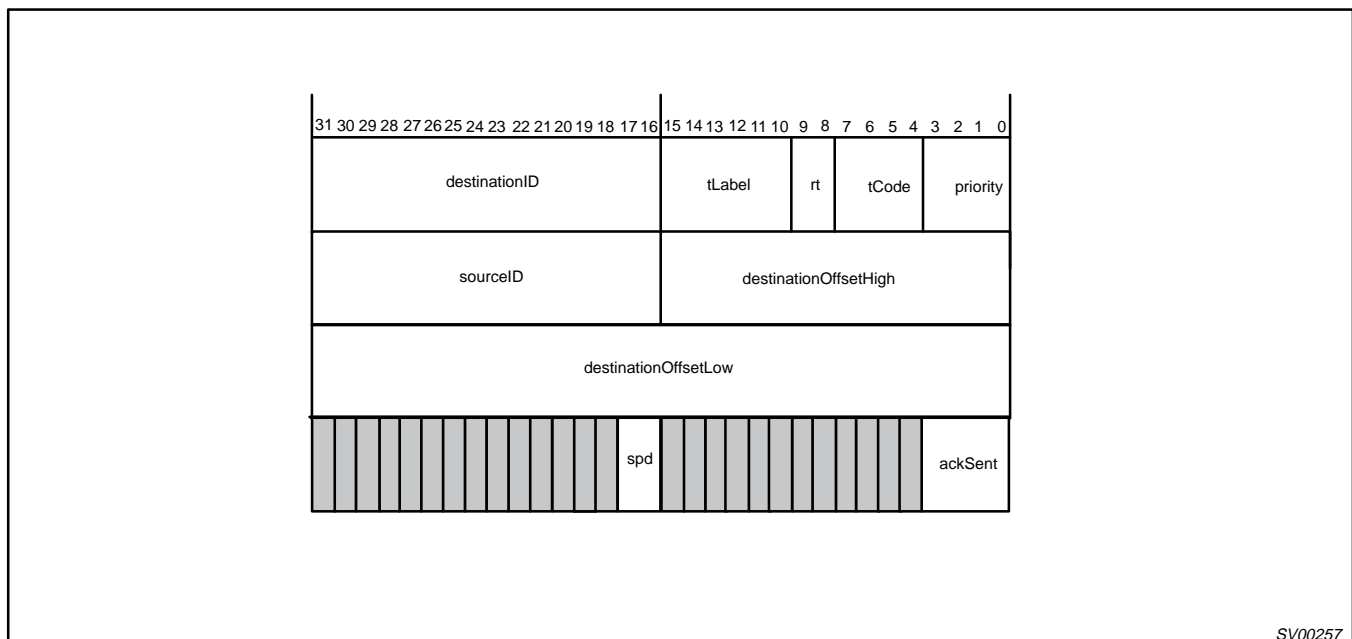

SV00257

Figure 10. Quadlet Read Request Receive Format

1394 AV link layer controller

PDI1394L11

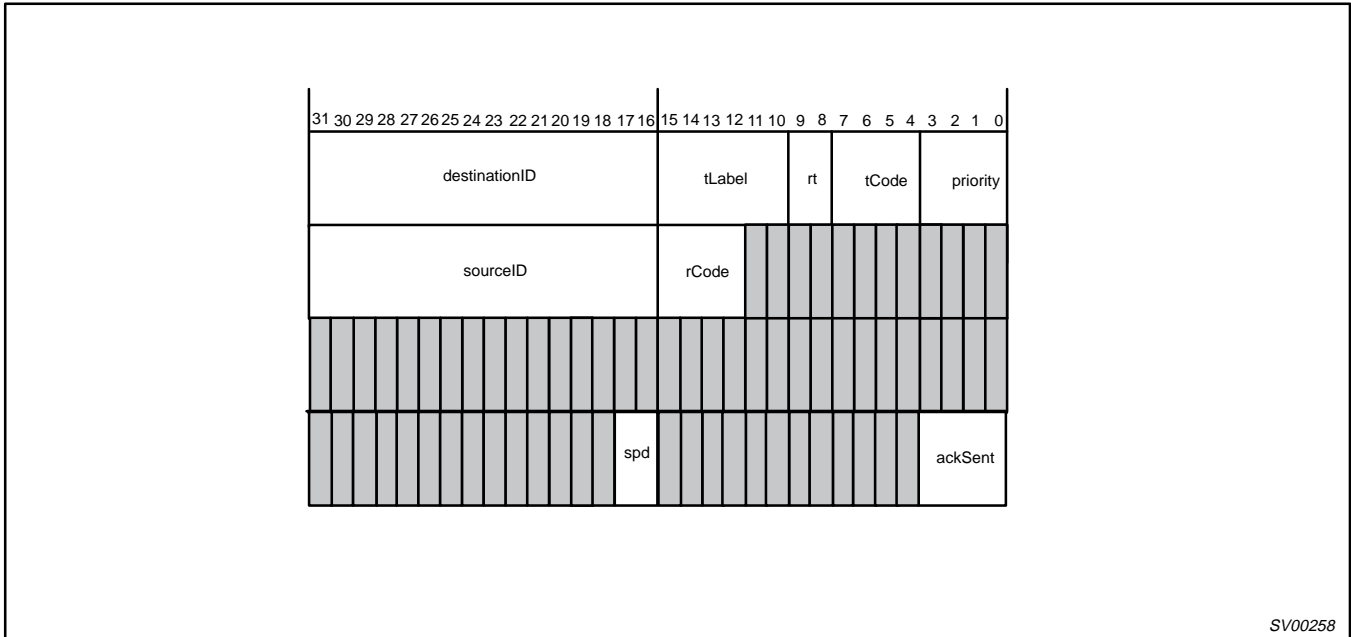

SV00258

Figure 11. Write Response Receive Format

12.5.2.2 Quadlet Receive

The quadlet receive formats are shown below. The first quadlet contains the destination node ID and the rest of the packet header. The second and third quadlets contain 16-bit source ID and either the 48-bit, quadlet-aligned destination offset (for requests) or the response code (for responses). The fourth quadlet is the quadlet data for read responses and write quadlet requests, and is the data length and reserved for block read requests. The last quadlet contains packet reception status.

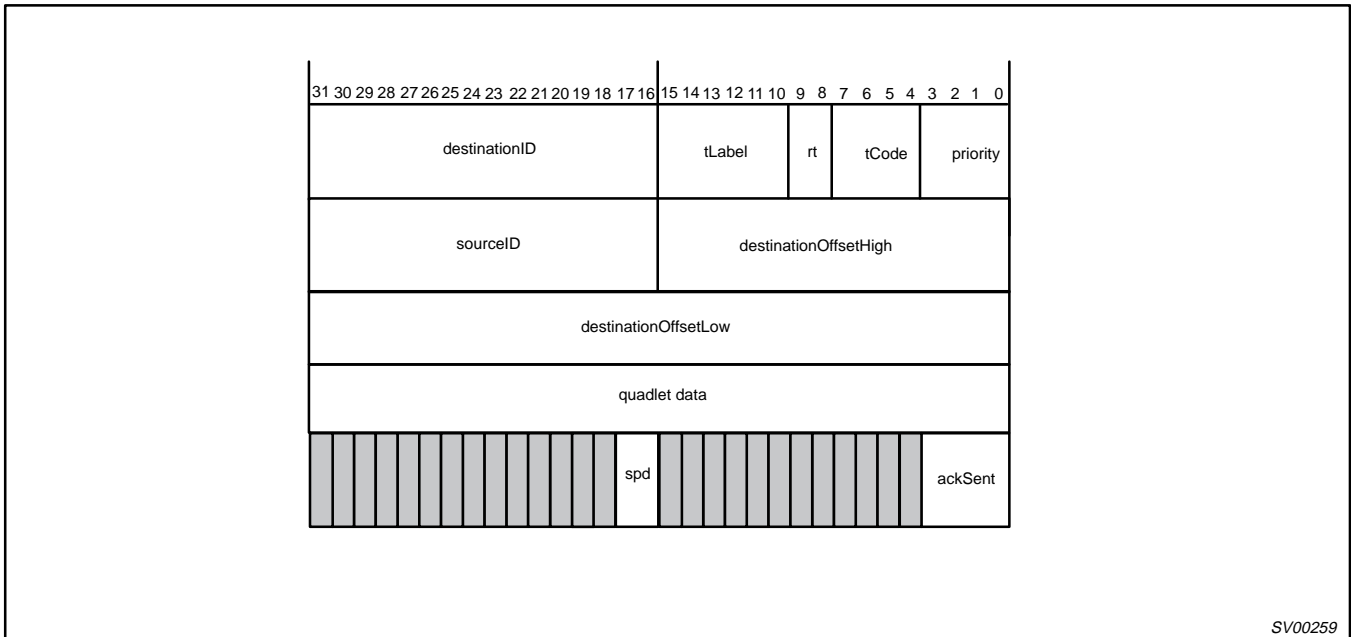

SV00259

Figure 12. Quadlet Read Request Receive Format

1394 AV link layer controller

PDI1394L11

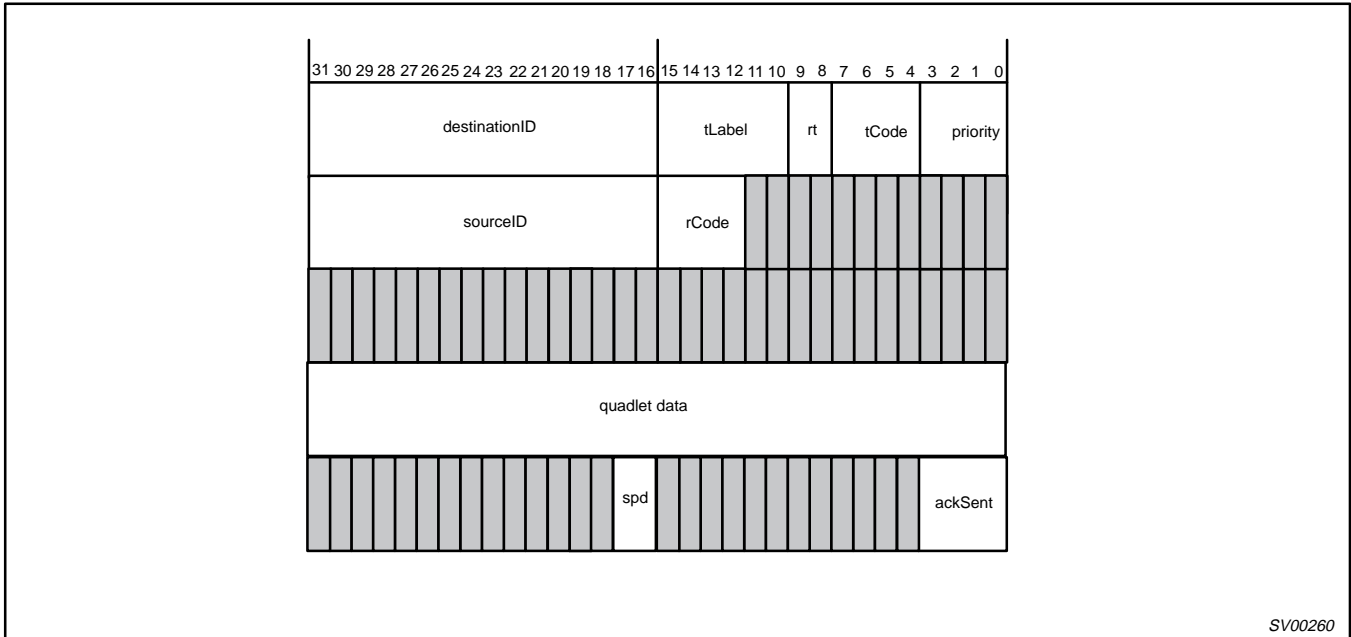

SV00260

Figure 13. Quadlet Read Response Receive Format

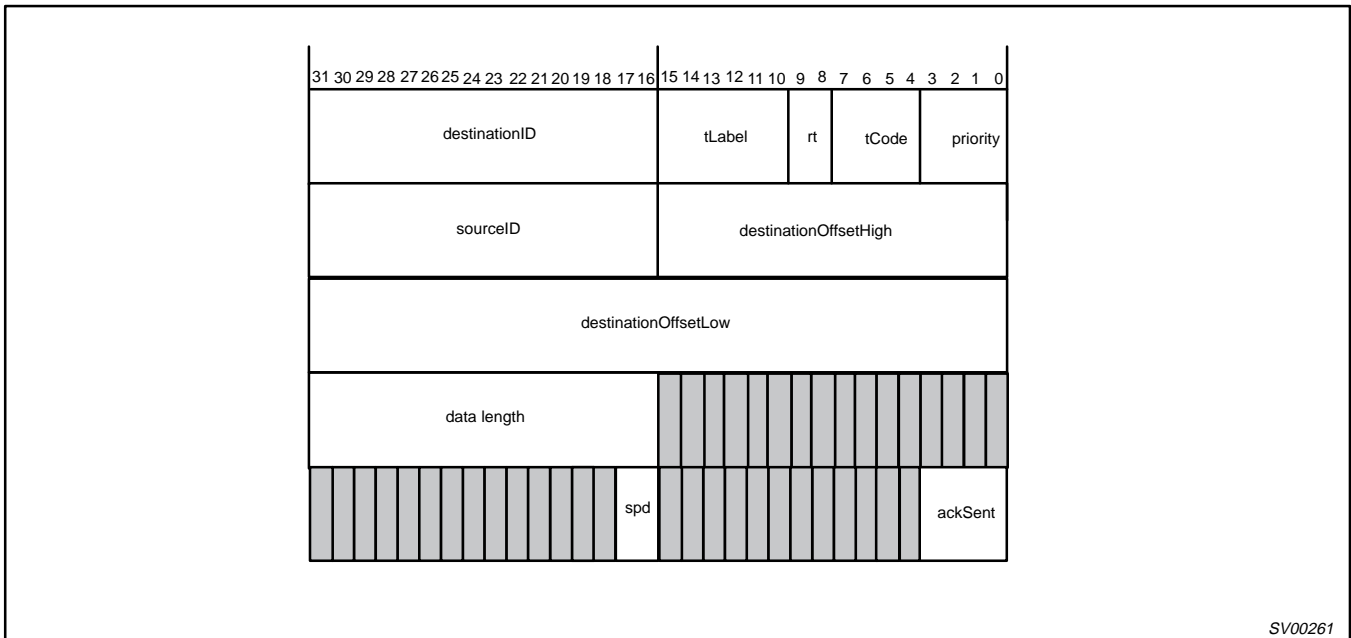

SV00261

Figure 14. Block Read Request Receive Format

1394 AV link layer controller

PDI1394L11

12.5.2.3 Block receive

The block receive format is shown below. The first quadlet contains the destination node ID and the rest of the packet header. The second and third quadlets contain 16-bit sourceID and either the 48-bit destination offset (for requests) or the response code and reserved data (for responses). The fourth quadlet contains the length of the data field and the extended transaction code (all zeros except for lock transactions). The block data, if any, follows the extended code. The last quadlet contains packet reception status.

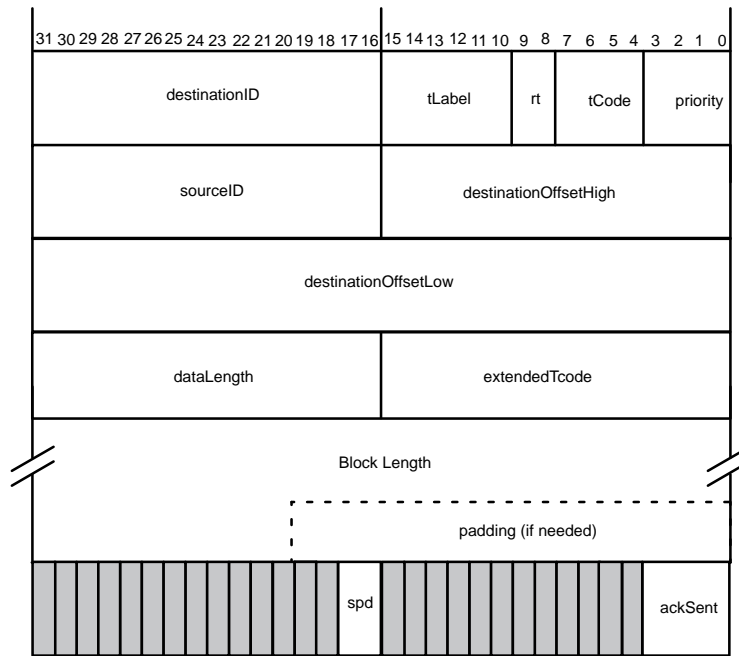

SV00262

Figure 15. Block Write or Lock Request Receive Format

1394 AV link layer controller

PDI1394L11

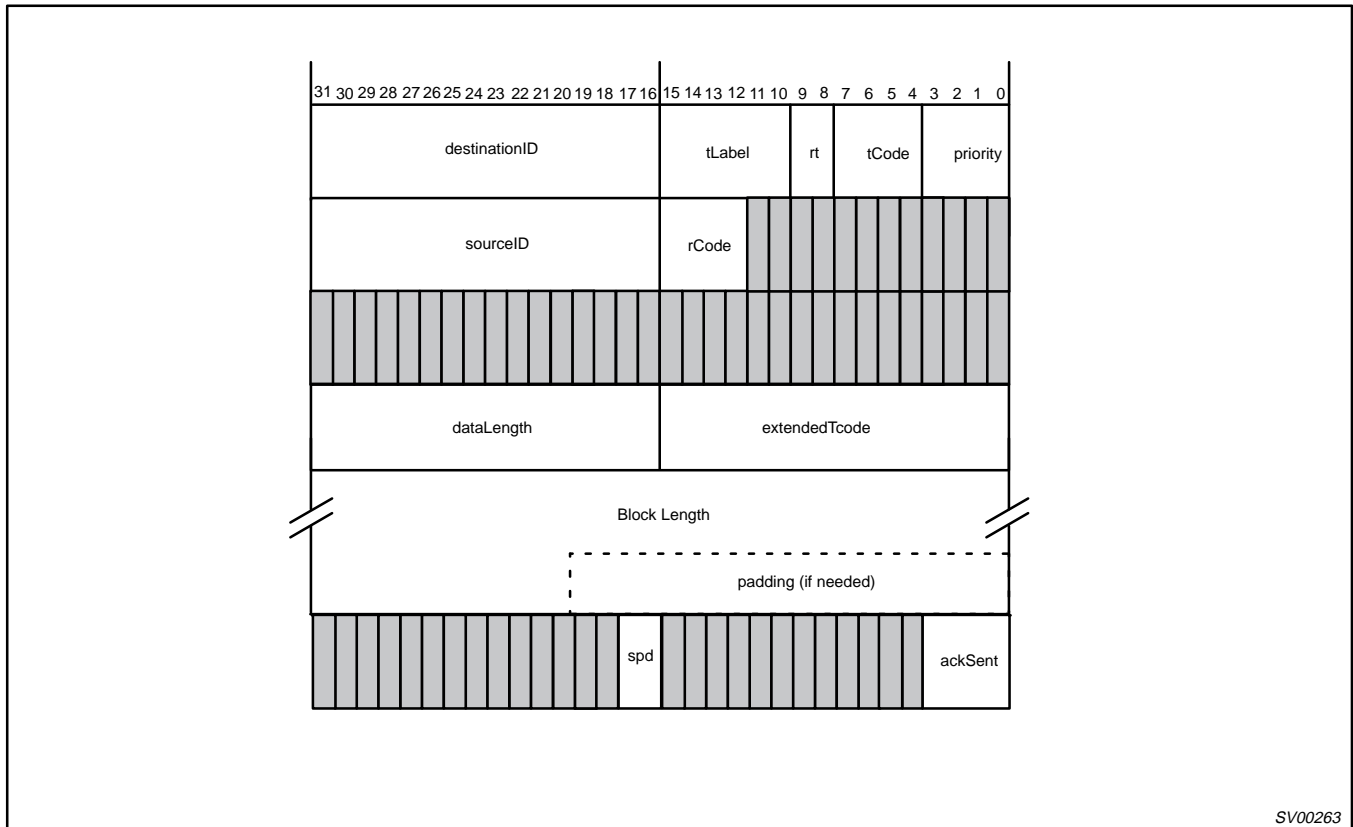

Figure 16. Block Read or Lock Response Receive Format

12.5.2.4 Self-ID and PHY packets receive

The self-ID and PHY packet receive formats are shown below. The first quadlet contains a synthesized packet header with a tCode of 0x0E (hex). For self-ID information, the remaining quadlets contain data that is received from the time a bus reset ends to the first subaction gap. This is the concatenation of all the self-ID packets received. Note that the bit-inverted check quadlet is included in the FIFO and the application must check it.

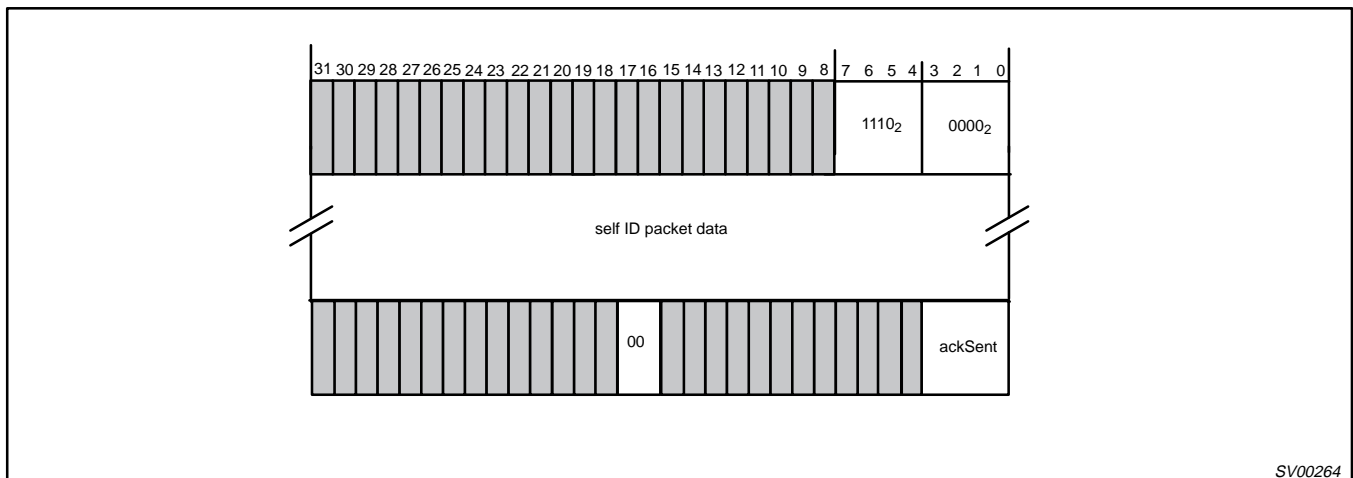

Figure 17. Self-ID Receive Format

The "ackSent" field will either be "ACK_DATA_ERROR" if a non-quadlet-aligned packet is received or there was a data overrun, or "ACK_COMPLETE" if the entire string of self-ID packets was received.

1394 AV link layer controller

PDI1394L11

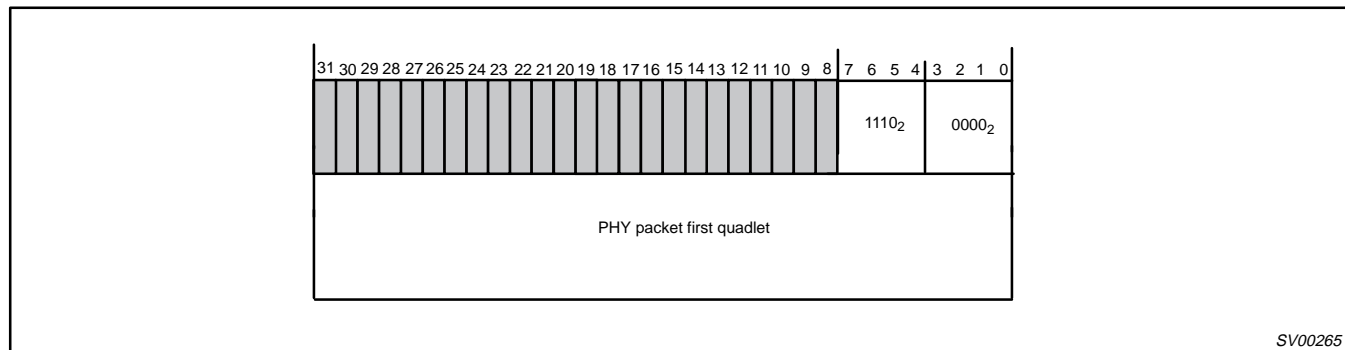

Figure 18. PHY Packet Receive Format

For PHY packets, there is a single following quadlet which is the first quadlet of the PHY packet. The check quadlet has already been verified and is not included.

12.5.3 Interrupts

The PDI1394L11 provides a single interrupt line (HIF INT_N) for connection to a host controller. Status indications from four major areas of the device are collected and ORed together to activate HIF INT_N. Status from four major areas of the device are collected in four status registers; LKPYINTA, ITXINTA, IRXINTA, and ASY_CR2. At this level, each individual status can be enabled to generate a chip-level interrupt by activating HIF INT_N. To aid in determining the source of a chip-level interrupt, the major area of the device generating an interrupt is indicated in the lower 4 bits of the GENINT register. These bits are non-latching status bits and do not need to be acknowledged. To acknowledge and clear a standing interrupt, the bit in LKPYINTA, ITXINTA, IRXINTA, or ASY_CR2 causing the interrupt status has to be acknowledged.

12.5.3.1 Determining and Clearing Interrupts

When responding to an interrupt event generated by the PDI1394L11, or operating in polled mode, the first register examined is the GENINT register. The least significant nibble contains interrupt status bits from general sections of the device; the link layer controller, the AV transmitter, the AV receiver, and the asynchronous transceiver. The bits in GENINT[3:0] are self-clearing status bits. They represent the logical OR of all the enabled interrupt status bits in their section of the AV Link Layer Controller.

Once an interrupt, or status is detected in GENINT, the appropriate interrupt status register needs to be read, see the Interrupt Hierarchy diagram for more detail. After all the interrupt indications are dealt with in the appropriate interrupt status register, the interrupt status indication will automatically clear in the GENINT.

All interrupt status bits in the various interrupt status registers are latching unless otherwise noted.

1394 AV link layer controller

PDI1394L11

12.5.3.2 Interrupt Hierarchy

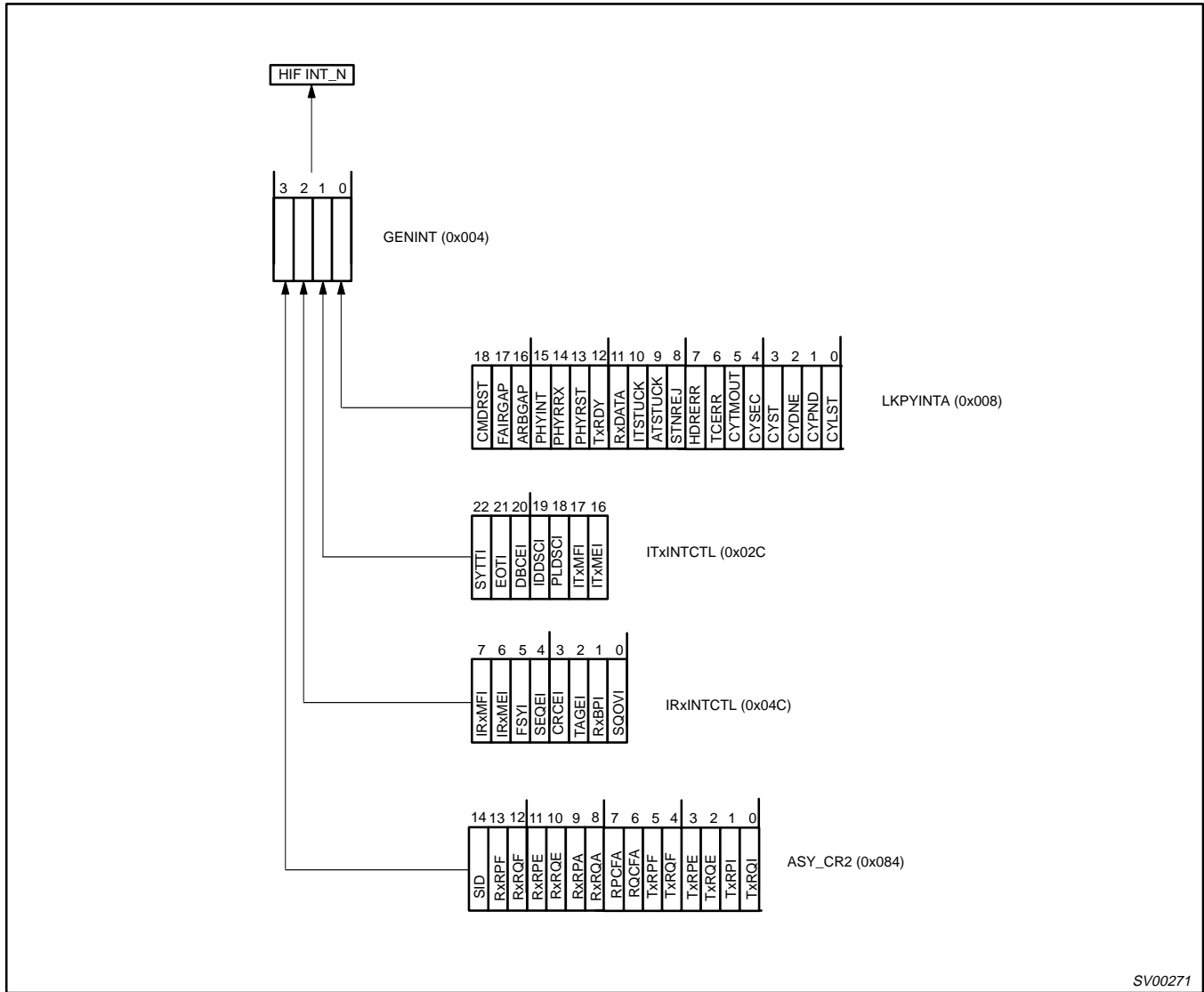

1394 AV link layer controller

PDI1394L11

13.0 REGISTER MAP

13.1 Link Control Registers

13.1.1 ID Register (ID) – Base Address: 0x000

The ID register is automatically updated by the attached PHY with the proper Node ID after completion of the bus reset.

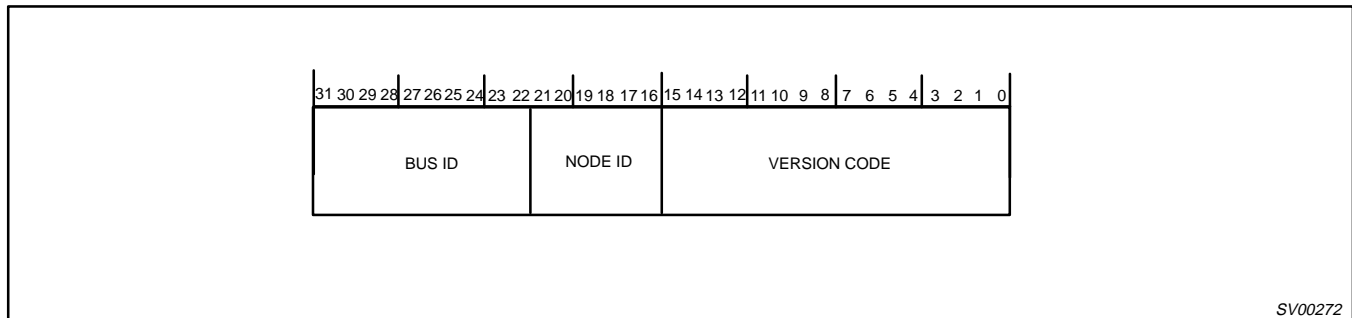

Reset Value 0xFFFF0001

- Bit 31..22: R/W Bus ID: The 10-bit bus number that is used with the Node ID in the source address for outgoing packets and used to accept or reject incoming packets.
- Bit 21..16: R/W Node ID: Used in conjunction with Bus ID in the source address for outgoing packets and used to accept or reject incoming packets. This register auto-updates with the node ID assigned after the 1394 bus Tree-ID sequence.
- Bit 15..0: R Version Code: Version of the PDI1394L11

13.1.2 General Link Control (GENCTL) – Base Address: 0x004

The General Link control register is used to program the Link Layer isochronous transceiver, as well as the overall link transceiver. It also provides general link status.

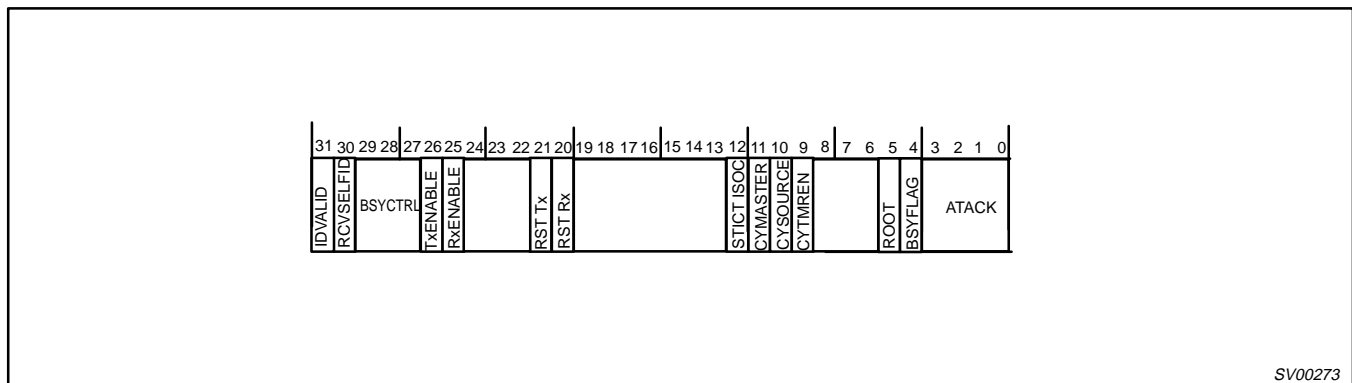

Reset Value 0x40300000

- Bit 31: R/W ID Valid: When equal to one, the PDI1394L11 accepts the packets addressed to this node.
- Bit 30: R/W Receive Self ID: When asserted, the self-identification packets, generated by each PHY device on the bus, during bus initialization are received and placed into the asynchronous request queue as a single packet.
- Bit 29..27: R/W Busy Control: These bits control what busy status the chip returns to incoming packets. The field is defined below:
 - 000 = follow normal busy/retry protocol, only send busy when necessary
 - 001 = send busy A when it is necessary to send a busy acknowledge
 - 010 = send a busy B when it is necessary to send a busy acknowledge
 - 011 = reserved
 - 100 = send a busy acknowledge to all incoming packets following the normal busy/retry protocol
 - 101 = send a busy acknowledge to all incoming packets by sending a busyA acknowledge
 - 111 = reserved
- Bit 26: R/W Transmitter Enable: When this bit is set, the link layer transmitter will arbitrate and send packets.
- Bit 25: R/W Receiver Enable: When this bit is set, the link layer receiver will receive and respond to bus packets.

1394 AV link layer controller

PDI1394L11

Bit 21:	R/W	Reset Transmitter: When set to one, this synchronously resets the transmitter within the link layer.
Bit 20:	R/W	Reset Receiver: When set to one, this synchronously resets the receiver within the link layer.
Bit 12:	R/W	Strict Isochronous: Used to accept or reject packets sent outside of specified isochronous cycles (between a Cycle Start and subaction gap). A "1" rejects packets sent outside the specified cycles, a "0" accepts isochronous packets sent outside the specified cycle. For standard operation, this bit should be set.
Bit 11:	R/W	Cycle Master: When asserted the PDI1394L11 is attached to the root PHY (ROOT bit = 1). When the cycle_count field of the cycle timer register increments, the transmitter sends a cycle-start packet.
Bit 10:	R/W	Cycle Source: When asserted, the cycle_count field increments and the cycle_offset field resets for each positive transition of CYCLEIN. When deasserted, the cycle count field increments when the cycle_offset field rolls over.
Bit 9:	R/W	Cycle Timer Enable: When asserted, the cycle offset field increments.
Bit 5:	R	Root: Indicates this device is the root on the bus.
Bit 4:	R	Busy Flag: The type of busy acknowledge which will be sent next time an acknowledge is required. 0 = Busy A, 1 = Busy B (only meaningful during a dual-phase busy/retry operation).
Bit 3..0:	R	AT acknowledge received: The last acknowledge received by the transmitter in response to a packet sent from the transmit-FIFO interface while the ATF is selected.

13.1.3 Link /Phy Interrupt Acknowledge (LKPYNITA) – Base Address: 0x008

The Link/Phy Interrupt Acknowledge register indicates various status and error conditions in the Link and Phy which can be programmed to generate an interrupt. The interrupt enable register (LKPYNITE) is a mirror of this register. Acknowledgment of an interrupt is accomplished by writing a '1' to a bit in this register that is set. This action reset the bit indication to a '0'.

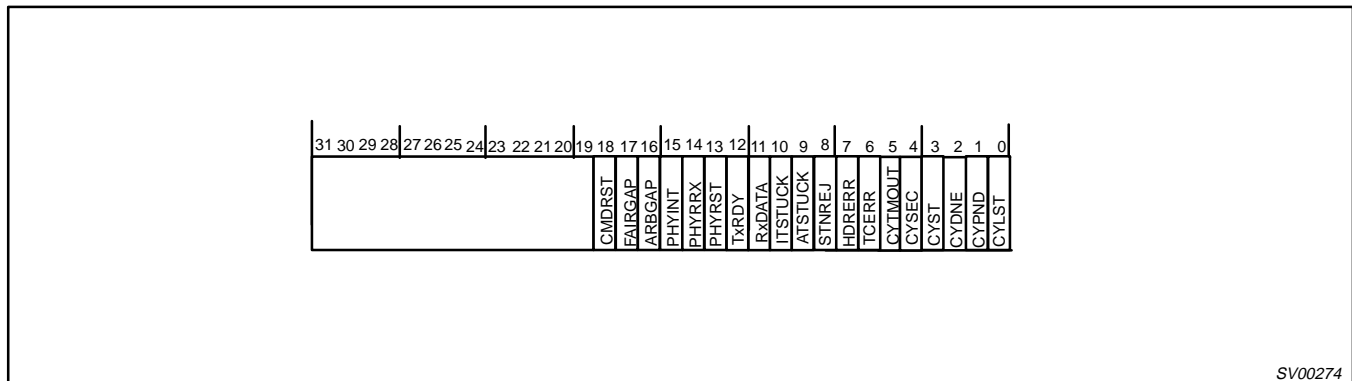

SV00274

Reset Value 0x00000000

Bit 18:	R/W	Command Reset Received: The receiver has confirmed data to the GRF interface.
Bit 17:	R/W	Fair Gap: The serial bus has been idle for a fair-gap time.
Bit 16:	R/W	Arbitration Reset Gap: The serial bus has been idle for an arbitration reset gap.
Bit 15:	R/W	Phy Chip Int: The Phy chip has signaled an interrupt through the Phy interface.
Bit 14:	R/W	Phy Register Information Received: A register has been transferred to the Phy chip input register.
Bit 13:	R/W	Phy Reset Started: A Phy-layer reconfiguration has started. This interrupt clears the ID valid bit.
Bit 12:	R/W	Transmitter Ready: The transmitter is idle and ready.
Bit 11:	R/W	Receiver has Data: The receiver has confirmed data to the GRF interface.
Bit 10:	R/W	Isochronous Transmitter is Stuck: The transmitter has detected invalid data at the transmit-FIFO interface when the ITF is selected.
Bit 9:	R/W	Asynchronous Transmitter is Stuck: The transmitter has detected invalid data at the transmit-FIFO interface when the ATF is selected.
Bit 8:	R/W	Busy Acknowledge Sent by Receiver: The receiver is forced to send a busy acknowledge to a packet addressed to this node because the GRF overflowed.
Bit 7:	R/W	Header Error: The receiver detected a header CRC error on an incoming packet that may have been addressed to this node.
Bit 6:	R/W	Transaction Code Error: The transmitter detected an invalid transaction code in the data at the transmit FIFO interface.
Bit 5:	R/W	Cycle Timed Out.
Bit 4:	R/W	Cycle Second incremented: The cycle second field in the cycle-timer register incremented. this occurs approximately every second when the cycle timer is enabled.
Bit 3:	R/W	Cycle Started: The transmitter has sent or the receiver has received a cycle start packet.

1394 AV link layer controller

PDI1394L11

- Bit 2: R/W Cycle Done: A fair gap has been detected on the bus after the transmission or reception of a cycle start packet. This indicated that the isochronous cycle is over.
- Bit 1: R/W Cycle Pending: Cycle pending is asserted when cycle timer offset is set to zero (rolled over or reset) and stays asserted until the isochronous cycle has ended.
- Bit 0: R/W Cycle Lost: The cycle timer has rolled over twice without the reception of a cycle start packet. This only occurs when cycle master is not asserted.

13.1.4 Link / Phy Interrupt Enable (LKPYINTE) – Base Address: 0x00C

This register is a mirror of the Link/Phy Interrupt Acknowledge (LKPYINTA) register. Enabling an interrupt is accomplished by writing a '1' to the bit corresponding to the interrupt desired.

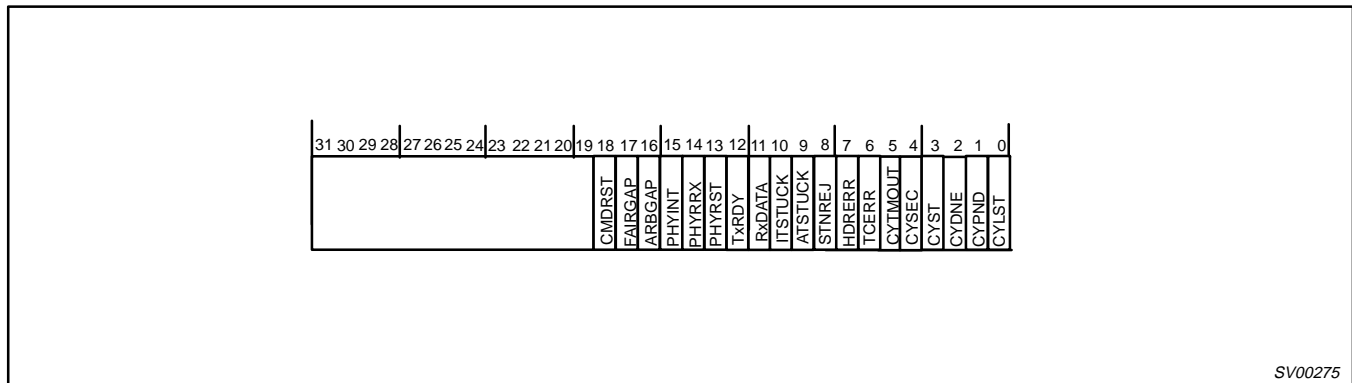

SV00275

This register enables the interrupts described in the Link /Phy Interrupt Acknowledge register description. A one in any of the bits enables that function to create an interrupt. A zero disables the interrupt, however the status is readable in the Link /Phy Interrupt Acknowledge register.

Reset Value 0x00000000

13.1.5 Cycle Timer Register (CYCTM) – Base Address: 0x010

Cycle Timer Register operation is controlled by the Cycle Timer Enable (CYTMREN) bit in the General Control Register.

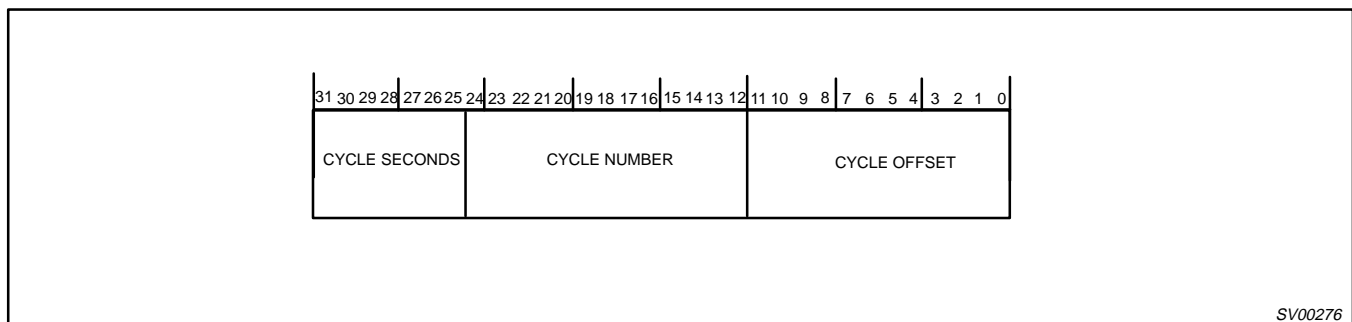

SV00276

Reset Value 0x00000000

- Bit 31..25: R/W Seconds count: 1–Hz cycle timer counter.
- Bit 24..12: R/W Cycle Number: 8kHz cycle timer counter.
- Bit 11..0: R/W Cycle Offset: 24.576MHz cycle timer counter.

13.1.6 Phy Register Access (PHYACS) – Base Address: 0x014

This register provides access to the internal registers on the Phy. There are special considerations when reading or writing to this register. When reading a PHY register, the address of the register is written to the Phy Rg Ad field with the Rd Phy bit set. The register is then read again until Rd Phy clears. Once this happens the register data is available in the Phy Rx Data, the address of the register just read is also

1394 AV link layer controller

PDI1394L11

available in the Phy Rx Ad fields. When writing a Phy register, the address of the register to be written is set in the Phy Rg Ad field and the data to be written to the register is set in Phy Rg Data, along with the WrPhy bit being set. Once the write is complete, the WrPhy bit will be cleared.

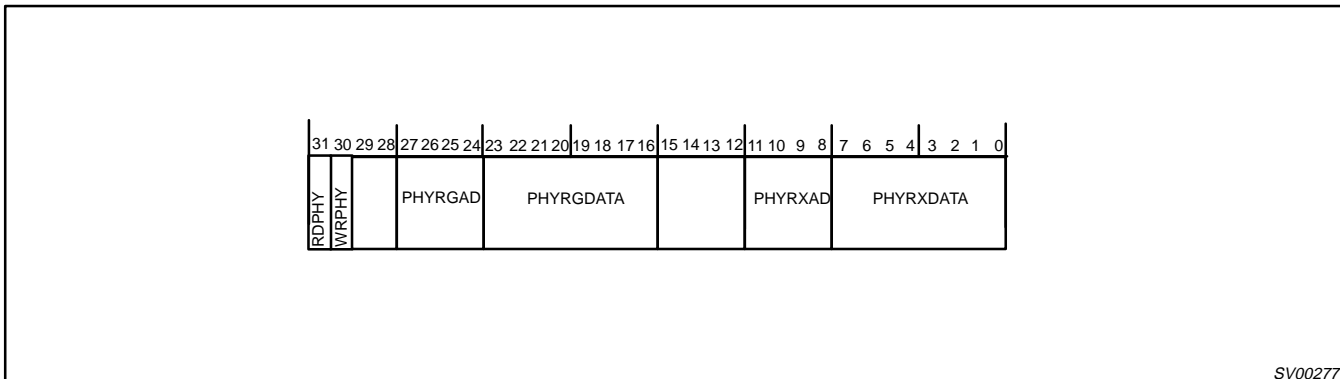

Reset Value 0x00000000

- Bit 31: R/W Read Phy Chip Register: When asserted, the PDI1394L11 sends a read register request with address equal to Phy Rg Ad to the Phy interface. This bit is cleared when the request is sent.
- Bit 30: R/W Write Phy Chip Register: When asserted, the PDI1394L11 sends a write register request with address equal to Phy Rg Ad to the Phy interface. This bit is cleared when the request is sent.
- Bit 27..24: R/W Phy Chip Register Address: This is the address of the Phy–chip register that is to be accessed.
- Bit 23..16: R/W Phy Chip Register Data: This is the data to be written to the Phy–chip register indicated in Phy Rg Ad.
- Bit 11..8: R Phy Chip Register Received Address: Address of register from which Phy Rx Data came.
- Bit 7..0: R Phy Chip Register Received Data: Data from register addressed by Phy Rx Ad.

13.1.7 General Interrupt Status and TX Control (GENINT) – Base Address: 0x018

This register is the top level interrupt status register. If the external interrupt line is set, this register will indicate which major portion of the AV Link generated the interrupt. There is no interrupt acknowledge required at this level. These bits auto clear when the interrupts in the appropriate section of the device clears all its interrupt statuses, or they are disabled. Control of the AV transceiver is also provided by this register.

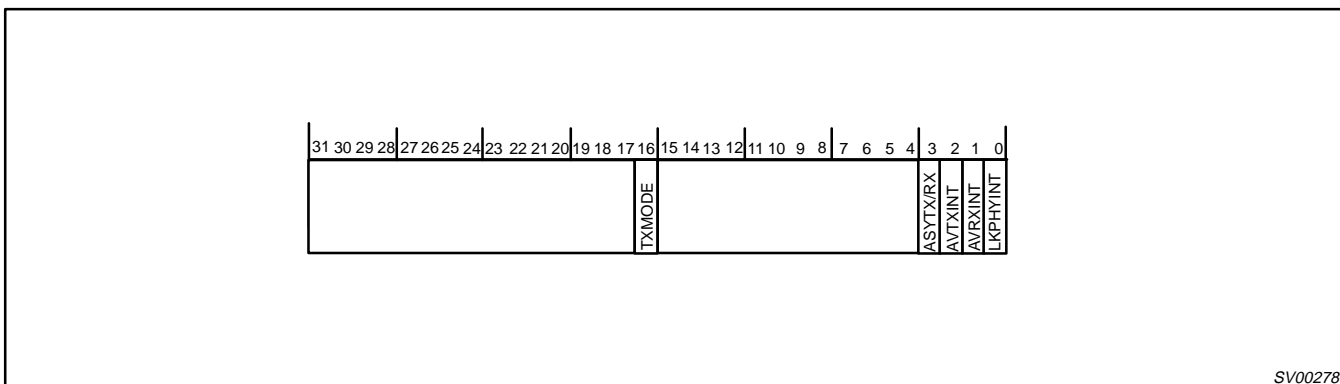

Bits 0 through 4 are used to identify to source of a general interrupt. When identified, the appropriate register needs to be read to find the exact source of the interrupt.

Reset Value 0x00010000

- Bit 16: R/W Transmit Mode: Control bit, a “1” enables the AV transmitter. A “0” enables the AV receiver. The register defaults to “1” on reset.
- Bit 3: R Asynchronous Transmitter/ Receiver Interrupt: Interrupt source is in the Asynchronous Transmitter/ Receiver Interrupt Acknowledge/Source register.
- Bit 2: R AV Transmitter Interrupt: Interrupt source is in the AV Transmitter Interrupt Acknowledge/Source register.
- Bit 1: R AV Receiver Interrupt: Interrupt source is in the AV Receiver Interrupt Acknowledge/Source register.
- Bit 0: R Link–Phy Interrupt: Interrupt source is in the Link Phy Interrupt Acknowledge register.

1394 AV link layer controller

PDI1394L11

13.2 AV Transmitter and Receiver Registers

13.2.1 AV Transmit Packing Control and Status (ITXCTL) – Base Address: 0x020

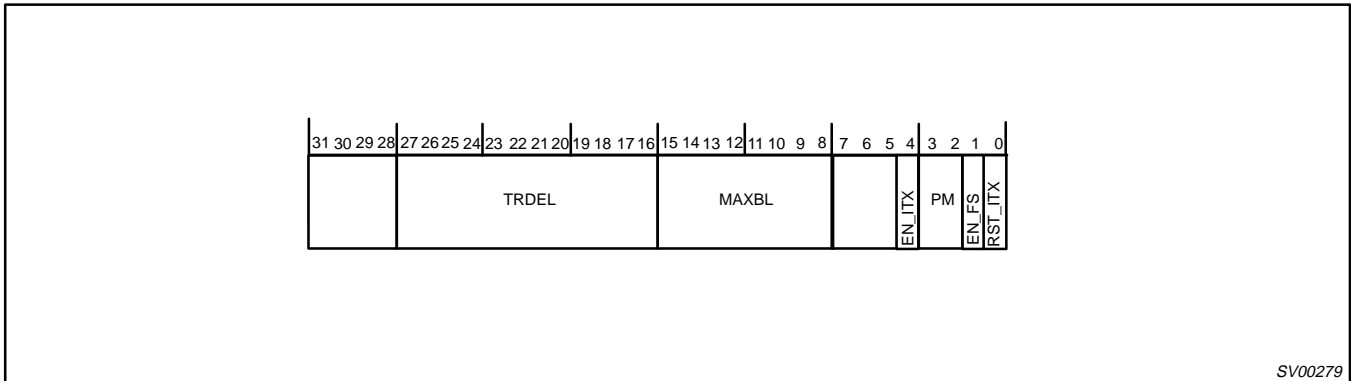

SV00279

Reset Value 0x00000001

- Bit 27..16: R/W TRDEL: Transport delay. Value added to time stamp before transmission takes place. Lower 4 bits add to upper 4 bits of cycle_offset. in the Cycle Timer Register.
- Bit 15..8: R/W MAXBL: The (maximum) number of data blocks to be put in a payload.
- Bit 4: R/W EN_ITX: Enable receipt of new application packets.
- Bit 3..2: R/W PM: packing mode:
 - 00 = variable sized bus packets, most generic mode.
 - 01 = fixed size bus packets.
 - 10 = MPEG-2 packing mode.
 - 11 = No data, just CIP headers are transmitted.
- Bit 1: R/W EN_FS:enable generation/insertion of SYT stamps in CIP header.
- Bit 0: R/W RST_ITX: Reset Isochronous Transmitter: causes transmitter to be reset when '1'.

13.2.2 AV Transmit Packing Control and Status (ITXPACK) – Base Address: 0x024

The AV Transmit Packing Control register holds the specification for the packing scheme used on the AV data stream. This information is included in Common Isochronous Packet (CIP) header quadlet 1.

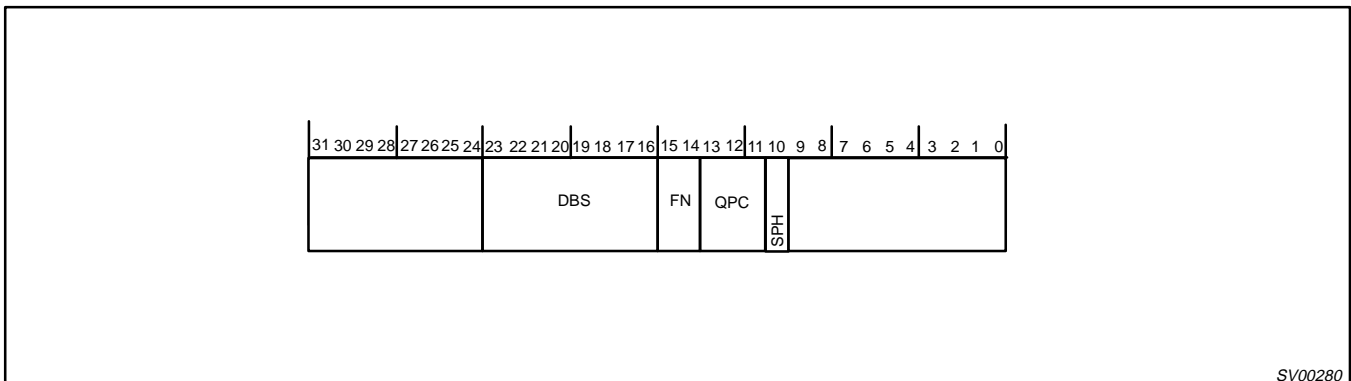

SV00280

Reset Value 0x00000000

- Bit 10: R/W SPH: Indicates that a CYCTM based time stamp has to be inserted before each application packet (the CYCTM bits to be included in the stamp are programmable through a mask).
- Bit 11..13: R/W QPC: Number of dummy quadlets to append to each source packet before it is divided into data blocks of the specified size. The value QPC must be less than DBS.
- Bit 14..15: R/W FN: The encoding for the number of data blocks into which each source packet shall be divided (00 = 1, 01 = 2, 10 = 4, 11 = 8).
- Bit 16..23: R/W DBS: Size of the data blocks from which AV payload is constructed. The value 0 represents a length of 256 quadlets.

1394 AV link layer controller

PDI1394L11

13.2.3 CIP header Quadlet 2 Control and Status (ITXHQ2) – Base Address: 0x028

The contents of this register are copied to the second quadlet of the CIP header and transmitted with each isochronous packet.

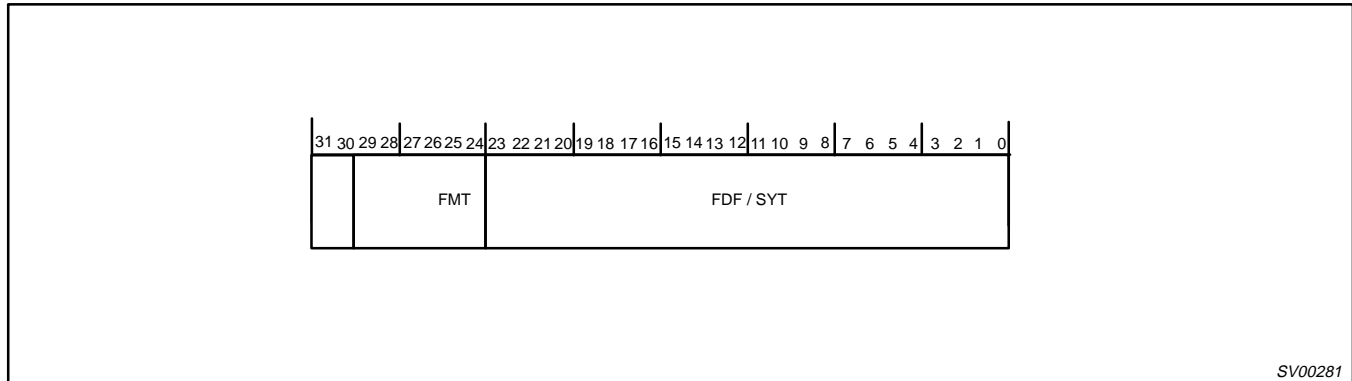

SV00281

Reset Value 0x00000000

- Bit 29..24: R/W FMT: Value to be inserted in the FMT field in the AV header.
- Bit 23..0: R/W FDF/SYT: Value to be inserted in the FDF field. When the EN_FS bit in the Transmit Control and Status Register is set (=1), the lower 16 bits of this register are replaced by an SYT stamp if a rising edge on AVFSYNCIN has been detected. Otherwise the lower 16 bits are set to all '1's. Also indicates whether or not SYT field set to all '1's. The upper 8 bits of the register are sent as they appear in the FDF register. When the EN_FS bit in the Transmit Control and Status Register is unset (=0), the full 24 bits can be set to any application specified value.

13.2.4 AV Transmitter Interrupt Control and Status (ITXINTCTL) – Base Address: 0x02C

The AV Transmitter Interrupt Control and Status register is the interrupt register for the AV transmitter.

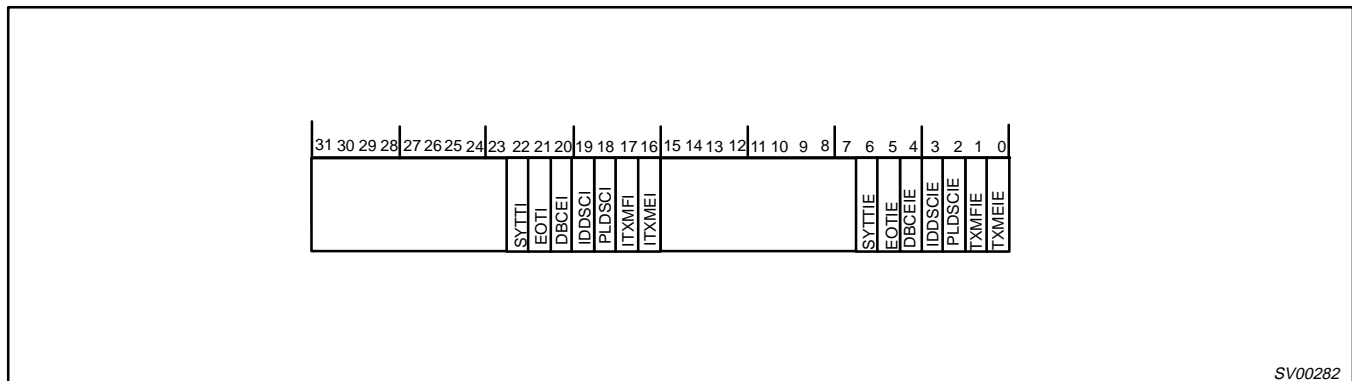

SV00282

Reset Value 0x00000000

- Bits 22 .. 16 are interrupt acknowledge bits. Writing a '1' clears the corresponding interrupt.
- Bit 22: R/W SYTTI: SYT transmitted in CIP header quadlet 2.
- Bit 21: R/W EOTI: Payload transmission/discard complete.
- Bit 20: R/W DBCEI: DBC synchronization lost.
- Bit 19: R/W IDDSCI: Input error (input data discarded).
- Bit 18: R/W PLDSCI: Lost cycle (payload discarded).
- Bit 17: R/W ITXMF I: Isochronous memory bank has become full.
- Bit 16: R/W ITXMEI: Isochronous memory bank has become empty.
- Bits 6 .. 0 are interrupt enable bits; and are defined as:
- Bit 6: R/W SYTTIE: Interrupt on transmission of a SYT in CIP header quadlet 2
- Bit 5: R/W EOTIE: Interrupt on payload transmission/discard complete.
- Bit 4: R/W DBCEIE: Interrupt on DBC synchronization loss.
- Bit 3: R/W IDDS CIE: Interrupt on input error (input data discarded).
- Bit 2: R/W PLDSCIE: Interrupt on lost cycle (payload discarded).
- Bit 1: R/W ITXMFIE: Interrupt on isochronous memory bank full.

1394 AV link layer controller

PDI1394L11

Bit 0: R/W ITXMEIE: Interrupt on isochronous memory bank empty.
 Other bits will always read '0'.
 Bits 31..16 are interrupt source indication ('1' means interrupt source active). ITXINTSRC: Bits 15..0 read back bits 15..0 from ITXINTCTL. See ITXINTCTL for meaning of bits.

13.2.5 AV Transmitter Isochronous Control (ITXISOCTL) – Base Address: 0x30

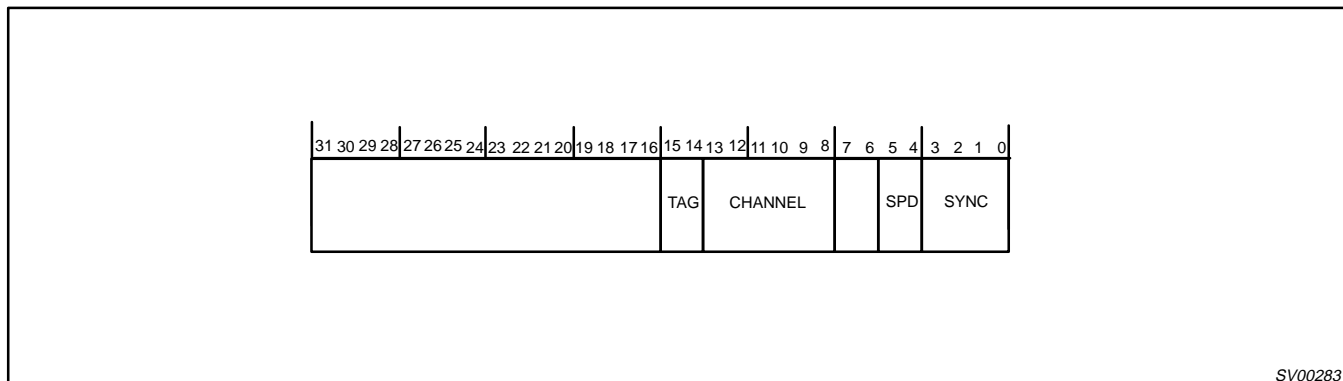

SV00283

Reset Value 0x00000000

Bit 15 .. 14: R/W Tag: Tag code to insert in isochronous bus packet header.
 Bit 13 .. 8: R/W Channel: Isochronous channel number.
 Bit 5 .. 4: R/W Speed: Cable transmission speed (S100, S200, S400).
 00=100Mbps
 01=200Mbps
 10=400Mbps
 11=reserved
 Bit 3 .. 0 R/W Sync: Code to insert in SY field of isochronous bus packet header.

13.2.6 AV Transmitter Memory Status (TMEMS) – Base Address: 0x034

The AV Transmitter Memory Status register reports on the condition of the internal memory buffer used to store incoming AV data streams before transmission over the 1394 bus.

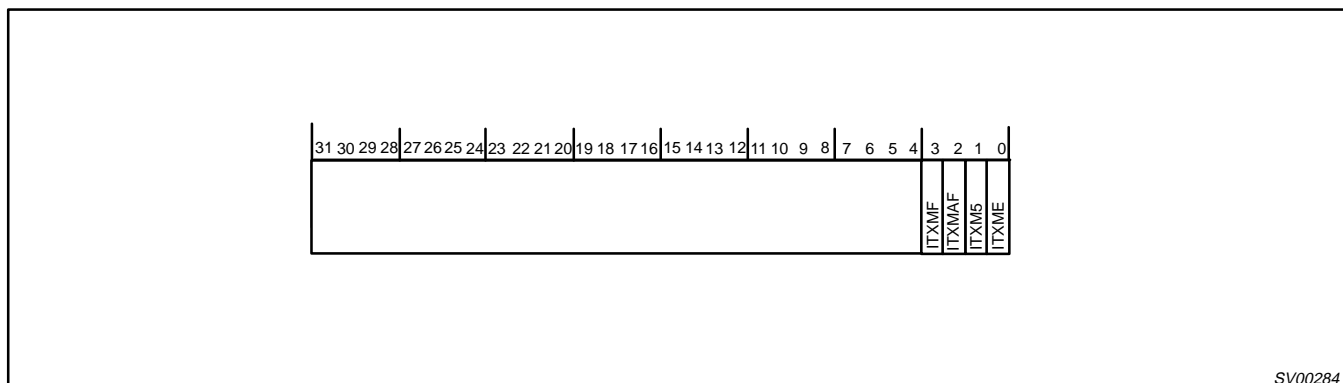

SV00284

Reset Value 0x00000003

Bit 3: R/W ITXMF: memory is completely full, no storage available.
 Bit 2: R/W ITXMAF: almost full, exactly one quadlet of storage available.
 Bit 1: R/W ITXM5: at least 5 more quadlets of storage available.
 Bit 0: R/W ITXME: memory bank is empty (zero quadlets stored).

1394 AV link layer controller

PDI1394L11

13.2.7 AV Isochronous Receiver Control and Status (IRXISOCTL) – Base Address: 0x040

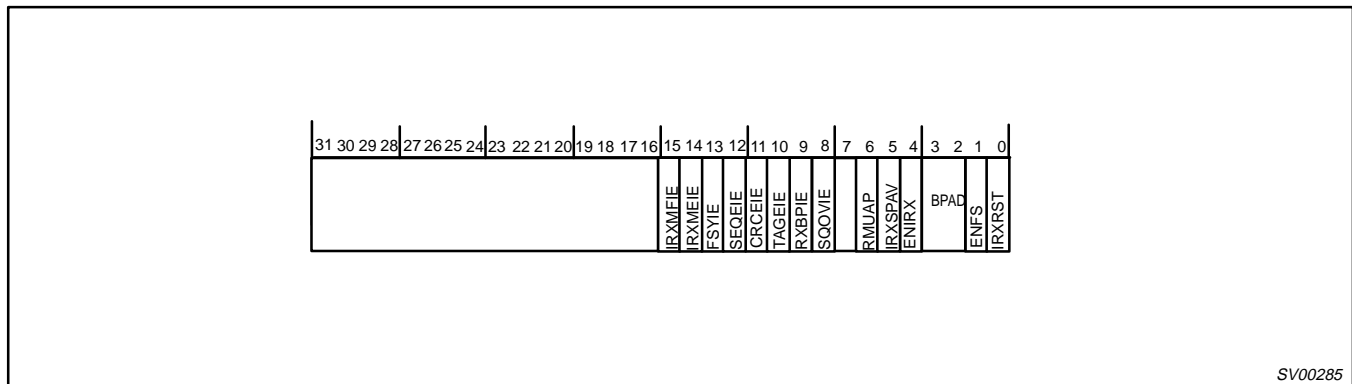

SV00285

Reset Value 0x00000041

Interrupt Enable Bits for AV Receiver.

- Bit 15: R/W IRXMFIE: Enable interrupt on memory bank full.
- Bit 14: R/W IRXMEIE: Enable interrupt on memory bank empty.
- Bit 13: R/W FSYIE: Enable interrupt on pulse at fsync output.
- Bit 12: R/W SEQEIE: Enable interrupt on Sequence error of data blocks.
- Bit 11: R/W CRCEIE: Enable interrupt on CRC error in bus packet.
- Bit 10: R/W TAGEIE: Enable interrupt on faulty CIP header tag (E,F bits).
- Bit 9: R/W RXBPIE: Enable interrupt on bus packet processing completion
- Bit 8: R/W SQOVIE: Enable interrupt on status queue overflow (serious internal error).

AV Receiver Control Bits.

- Bit 6: R/W RMUAP: Remove unreliable packets from memory, do not attempt delivery
- Bit 5: R/W IRXSPAV: Source packet available for delivery in buffer memory.
- Bit 4: R/W EN_IRX: Enable receiver operation. Value is only checked whenever a new bus packet arrives, so enable/disable while running is 'graceful'.
- Bit 2..3: R/W BPAD: Value indicating the amount of byte padding to be removed from the last data quadlet of each source packet, from 0 to 3 bytes.
- Bit 1: R/W EN_FS: Enable processing of SYT stamps.
- Bit 0: R/W IRXRST: causes the receiver to be reset when '1'.

13.2.8 AV Received Header Quadlet 1 (IRXHQ1S) – Base Address: 0x044

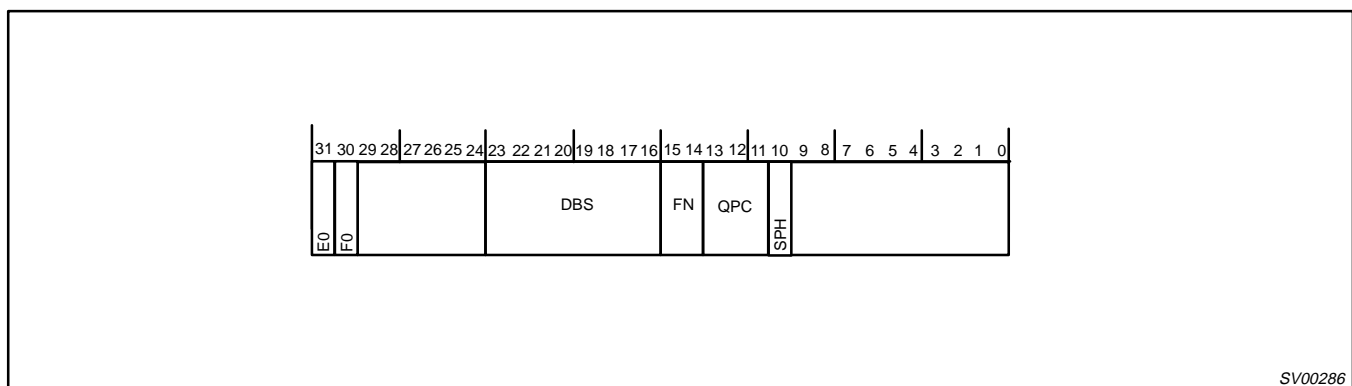

SV00286

Reset Value 0x00000000

- Bit 31..30: R E0: End of Header, F0: Format: Always set to 00 for first AV header quadlet
- Bit 29..24: R SID: Source ID, contains the node address of the sender of the isochronous data.
- Bit 23..16: R DBS: Size of the data blocks from which AV payload is constructed. The value 0 represents a length of 256 quadlets.
- Bit 15..14: R FN: The encoding for the number of data blocks into which each source packet shall be divided (00 = 1, 01 = 2, 10 = 4, 11 = 8).

1394 AV link layer controller

PDI1394L11

- Bit 13..11: R QPC: Number of dummy quadlets to append to each source packet before it is divided into data blocks of the specified size. The value QPC must be less than DBS.
- Bit 10: R SPH: Indicates that a CYCTM based time stamp has to be inserted before each application packet (the CYCTM bits to be included in the stamp are programmable through a mask).

13.2.9 AV Received Header Quadlet 2 (IRXHQS) – Base Address: 0x048

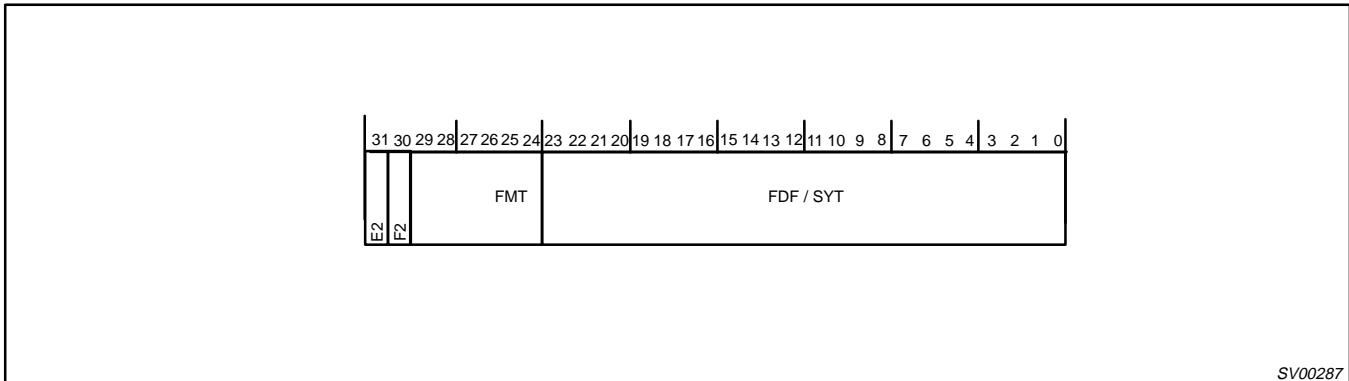

SV00287

Reset Value 0x0000FFFF

- Bit 31..30: R E1: End of Header, F1: Format: Always set to 10 for first AV header quadlet.
- Bit 29..24: R FMT: Value to be inserted in the FMT field in the AV header.
- Bit 23..0: R FDF/SYT: Value to be inserted in the FDF field. Also indicates whether or not SYT field (lower 16 bits of FDF) should be used to transmit a 16 bit CYCTM based time stamp when fsync input has sensed a rising edge.

13.2.10 AV Receiver Interrupt Acknowledge (IRXINTACK) – Base Address: 0x04C

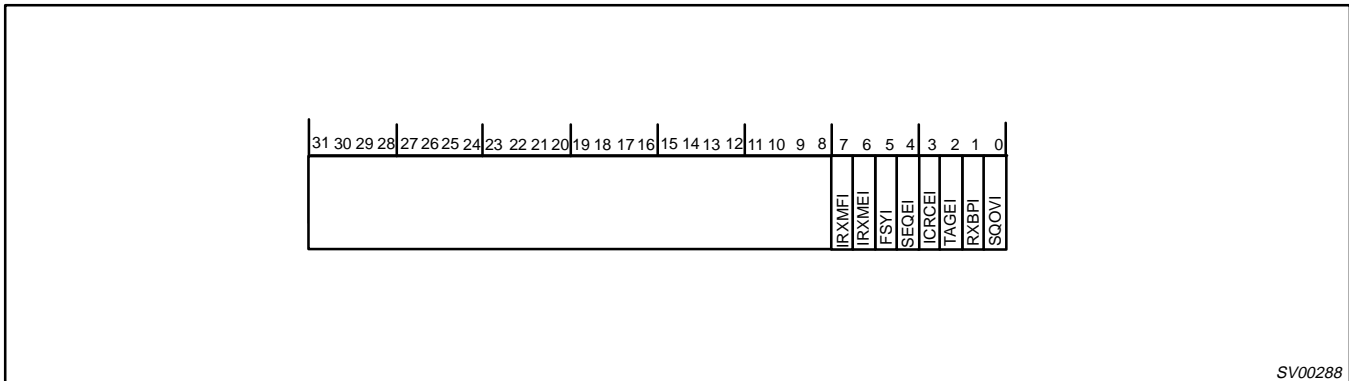

SV00288

Reset Value 0x00000000

- Bit 7: R/W IRXMF1: Isochronous data memory bank has become full.
- Bit 6: R/W IRXME1: Isochronous data memory bank has become empty.
- Bit 5: R/W FSYI: Pulse at fsync output.
- Bit 4: R/W SEQE1: Sequence error of data blocks.
- Bit 3: R/W ICRCE1: CRC error in bus packet.
- Bit 2: R/W TAGE1: Faulty CIP header tag (E,F bits).
- Bit 1: R/W RXBPI: Bus packet processing complete.
- Bit 0: R/W SQOVI: Status queue overflow.

1394 AV link layer controller

PDI1394L11

13.2.11 AV Isochronous Receiver Control and Status (IRXISOCTL) – Base Address: 0x050

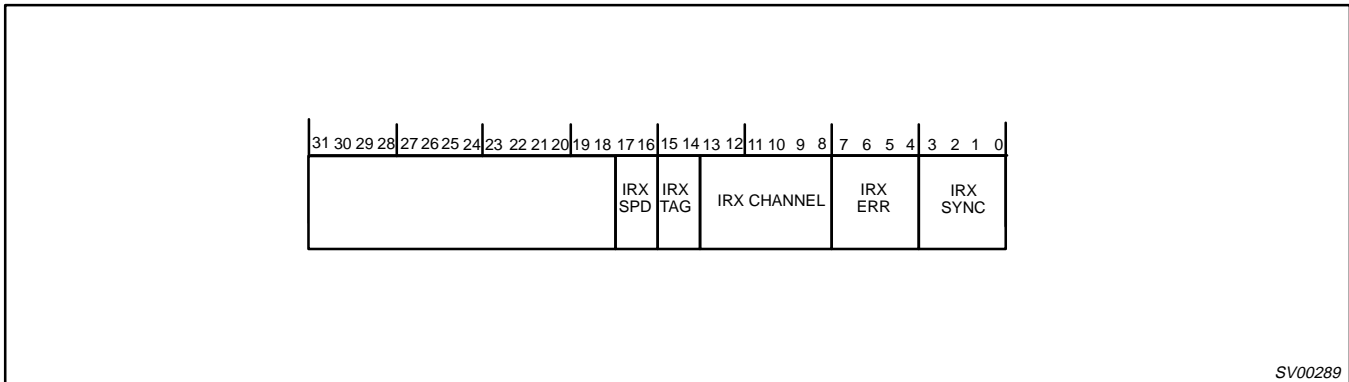

Reset Value 0x000000x0

- Bit 17 .. 16: R IRXSPD: Speed of last received isochronous packet (S100 .. S400).
- Bit 15 .. 14: R/W IRXTAG: Isochronous tag value (must match) for AV format.
- Bit 13 .. 8: R/W IRXCHAN: Channel number to receive isochronous data.
- Bit 7 .. 4: R IRXERR: Error code for last received isochronous AV packet.
- Bit 3 .. 0: R IRXSYNC: Last received SY code in isochronous. bus packet header.

13.2.12 AV Receiver Memory Status (RXMEMS) – Base Address: 0x054

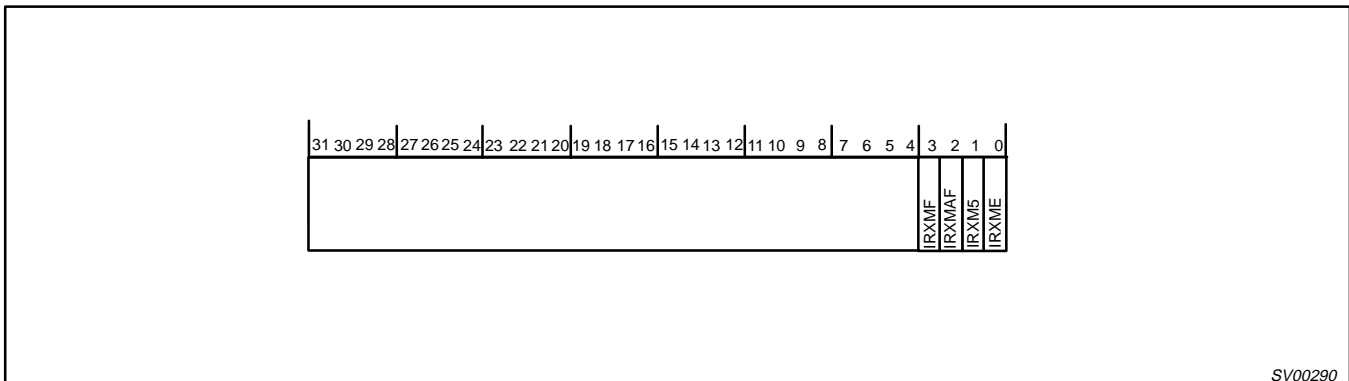

Reset Value 0x00000003

- Bit 3: R IRXMF: Full: no space available.
- Bit 2: R IRXMAF: Almost full: exactly one quadlet of storage available.
- Bit 1: R IRXM5: At least 5 more quadlets of storage available.
- Bit 0: RI IRXME: Memory bank is empty (no data committed).

1394 AV link layer controller

PDI1394L11

13.3 Asynchronous Control and Status Interface

13.3.1 Asynchronous RX/TX Control 1 (ASY_CR1) – Base Address: 0x080

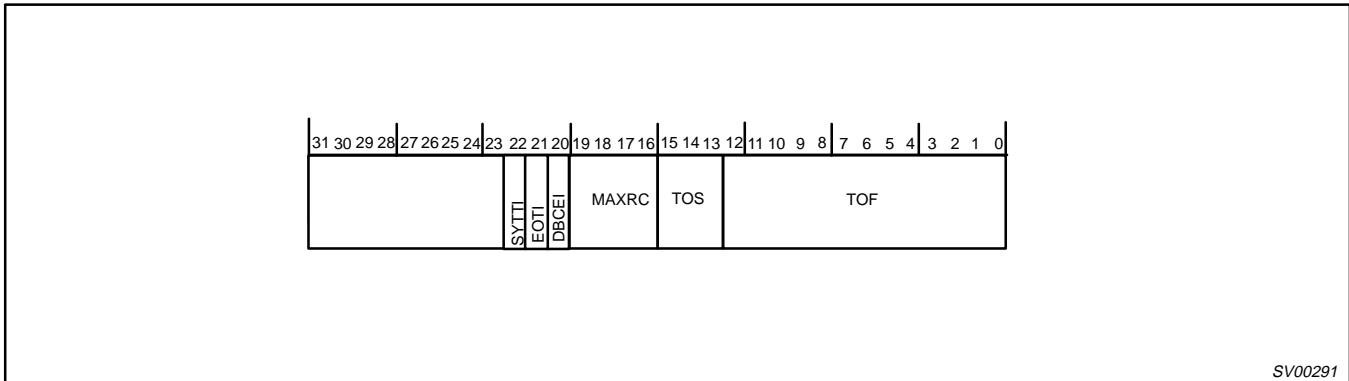

SV00291

Reset Value 0x00300320

- Bit 22: R/W INTENA: Enables interrupts from the asynchronous transmitter and receiver
- Bit 21: R/W ASYRST: ASY transceiver module reset
- Bit 20: R/W ARXALL: Receive all asynchronous packets addressed to this node
- Bit 19..16: R/W MAX_RC: Maximum number of asynchronous transmitter single phase retries
- Bit 15..13: R/W TOS: Time out seconds, integer of 1 second
- Bit 12..0: R/W TOF: Time out fractions, integer of 1/8000 second

13.3.2 Asynchronous RX/TX Control 2 (ASY_CR2) – Base Address: 0x084

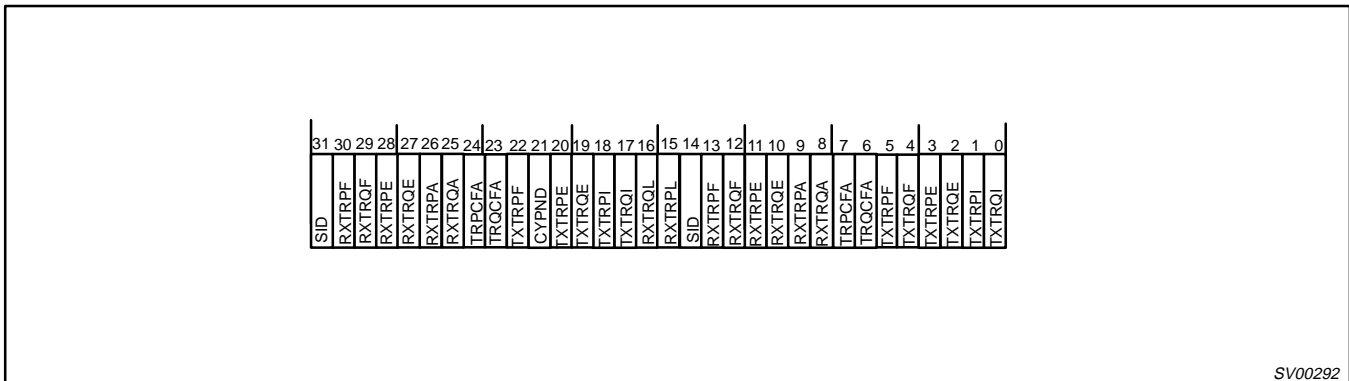

SV00292

Reset Value 0x00000003

- Bit 30..17..30: interrupt enable
- Bit 31: R/W SID: Receiver self-ID packet available at response queue
- Bit 30: R/W RXRPF: Receiver response queue full
- Bit 29: R/W RXRQF: Receiver request queue full
- Bit 28: R/W RXRPE: Receiver response queue read error
- Bit 27: R/W RXRQE: Receiver request queue read error
- Bit 26: R/W RXRPA: Receiver response queue quadlet available
- Bit 25: R/W RXRQA: Receiver request queue quadlet available
- Bit 24: R/W RPCFA: Response confirmation available
- Bit 23: R/W RQCFA: Request confirmation available
- Bit 22: R/W TXRPF: Transmitter response queue full.
- Bit 21: R/W TXRQF: Transmitter request queue full
- Bit 20: R/W TXRPE: Transmitter response queue write error
- Bit 19: R/W TXRQE: Transmitter request queue write error
- Bit 18: R/W TXRPI: Transmitter response queue idle

1394 AV link layer controller

PDI1394L11

- Bit 17: R/W TXRQIB: Transmitter request queue idlebusy
- Bit 16: R RXRQL: Receiver request queue contains last quadlet
- Bit 15: R RXRPL: Receiver response queue contains last quadlet
- Bit 14: R/W SID: Receiver self-ID packet available at response queue
- Bit 13: R/W RXRPF: Receiver response queue full
- Bit 12..0: INTVEC: Interrupt vector
- Bit 12: R/W RXRQF: Receiver request queue full
- Bit 11: R/W RXRPE: Receiver response queue read error
- Bit 10: R/W RXRQE: Receiver request queue read error
- Bit 9: R/W RXRPA: Receiver response queue quadlet available
- Bit 8: R/W RXRQA: Receiver request queue quadlet available
- Bit 7: R/W RPCFA: Response confirmation available
- Bit 6: R/W RQCFA: Request confirmation available
- Bit 5: R/W TXRPF: Transmitter response queue full.
- Bit 4: R/W TXRQF: Transmitter request queue full
- Bit 3: R/W TXRPE: Transmitter response queue write error
- Bit 2: R/W TXRQE: Transmitter request queue write error
- Bit 1: R/W TXRPIB: Transmitter response queue idlebusy
- Bit 0: R/W TXRQIB: Transmitter request queue idlebusy

13.3.3 Asynchronous Transmit Request Next (TX_RQ_NEXT) – Base Address: 0x088

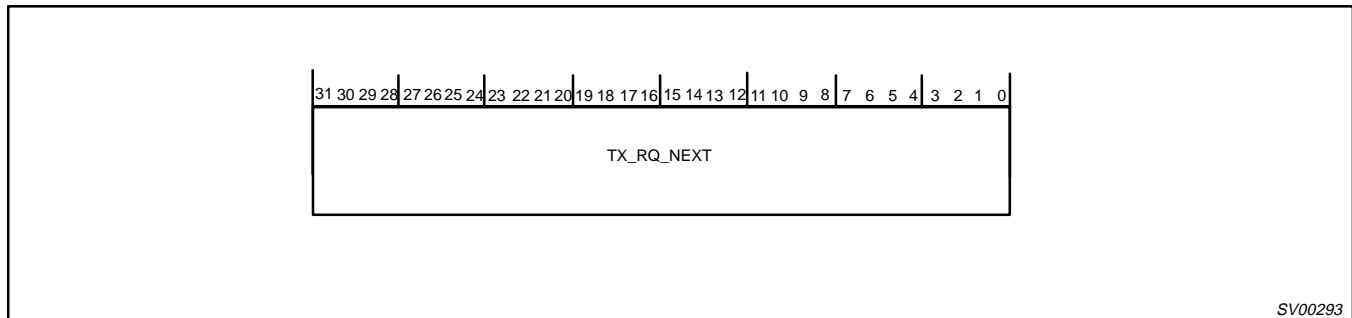

- Bit 31..0: W TX_RQ_NEXT: Write next request quadlet to ASY transmitter
Writing this register will clear the TXRQI flag until the quadlet has been written to its queue.

1394 AV link layer controller

PDI1394L11

13.3.4 Asynchronous Transmit Request Last (TX_RQ_LAST) – Base Address: 0x08C

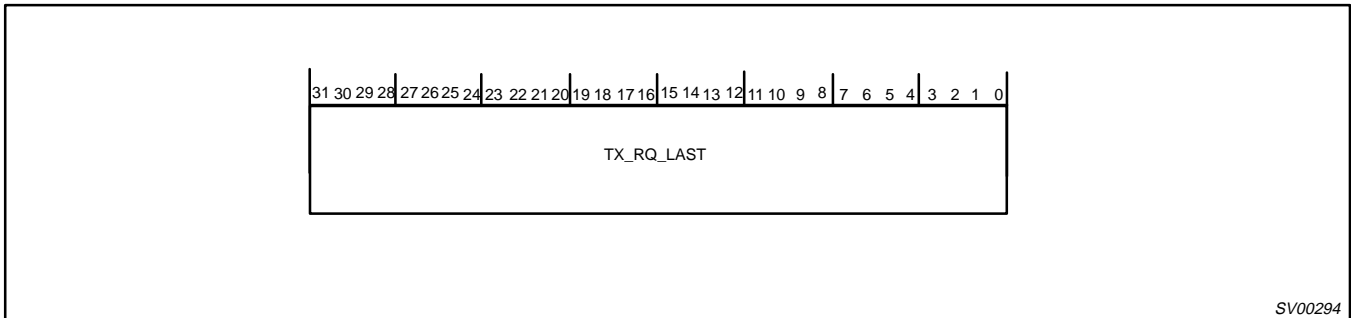

Bit 31..0: W TX_RQ_LAST: Write last request quadlet to ASY transmitter
 Writing this register will clear the TXRQI flag until the quadlet has been written to its queue.

13.3.5 Asynchronous Transmit Response Next (TX_RP_NEXT) – Base Address: 0x090

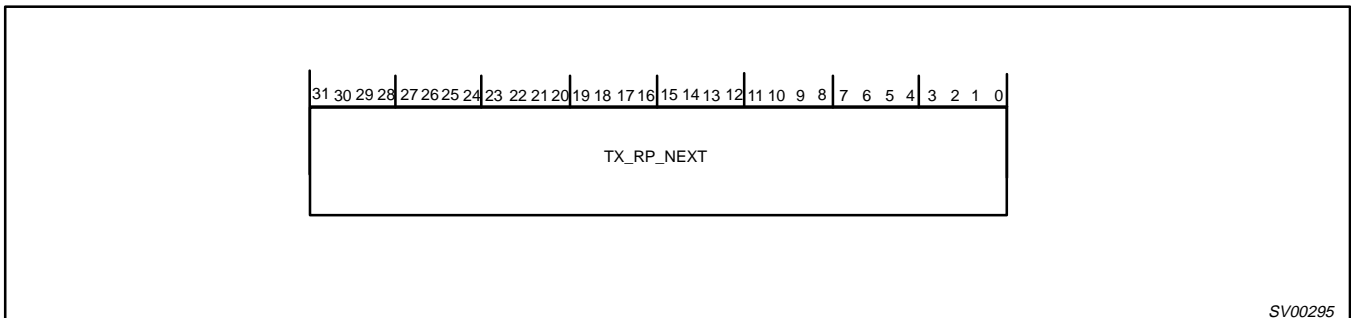

Bit 31..0: W TX_RP_NEXT: Write next request quadlet to ASY transmitter
 Writing this register will set the TXRPIB flag until the quadlet has been written to its queue.

13.3.6 Asynchronous Transmit Response (TX_RP_LAST) – Base Address: 0x094

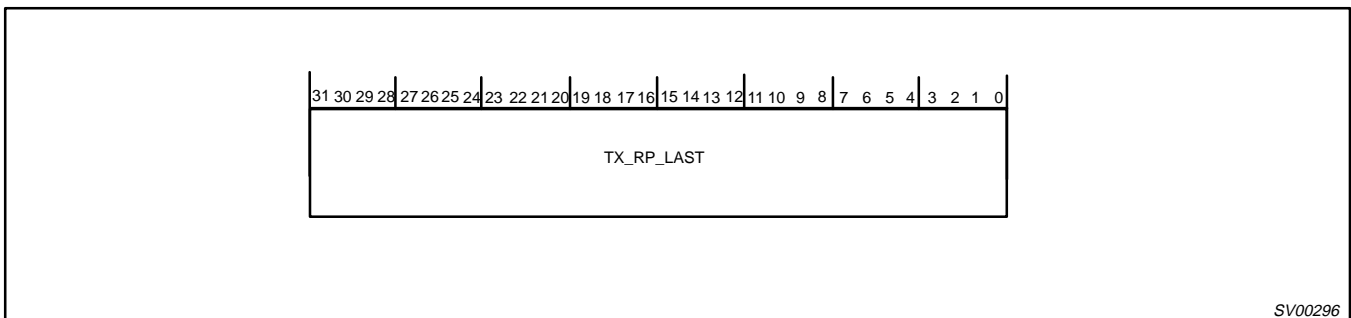

Bit 31..0: W TX_RP_LAST: Write next request quadlet to ASY transmitter
 Writing this register will clear the TXRPI flag until the quadlet has been written to its queue.

1394 AV link layer controller

PDI1394L11

13.3.7 Asynchronous Receive Request (RX_RQ) – Base Address: 0x098

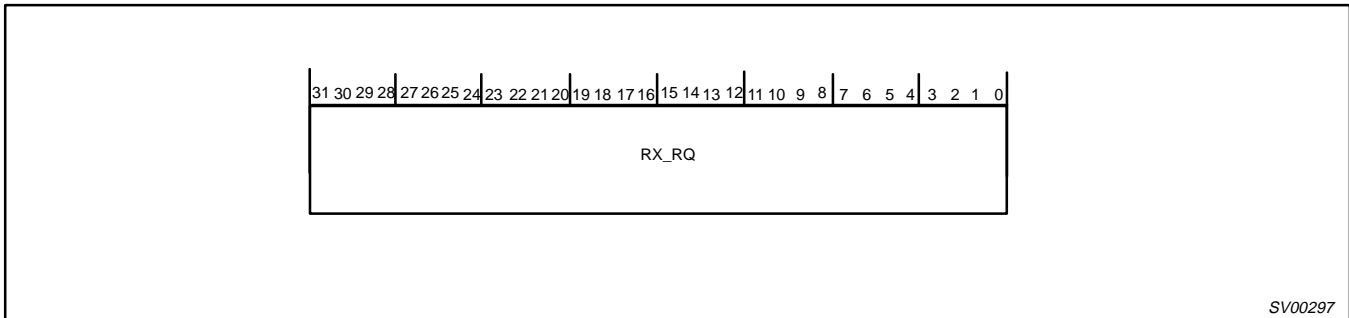

Reset Value 0x00000000

Bit 31..0: R RCV_RQ: Holds the current quadlet in the request queue.
 Reading this register will clear the RXRQA flag until the next received quadlet has been written to its queue.

13.3.8 Asynchronous Receive Response (RX_RP) – Base Address: 0x09C

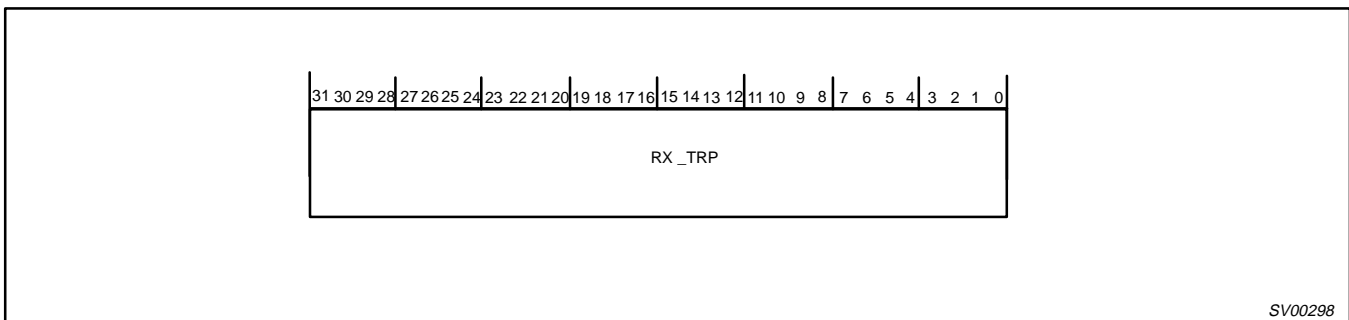

Reset Value 0x00000000

Bit 31..0: R RX_RP: Holds the current quadlet in the response queue.
 Reading this register will clear the RXRPA flag until the next received quadlet has been written to its queue.

13.3.9 Asynchronous Receive Request Status (RX_RQCF) – Base Address: 0x0A0

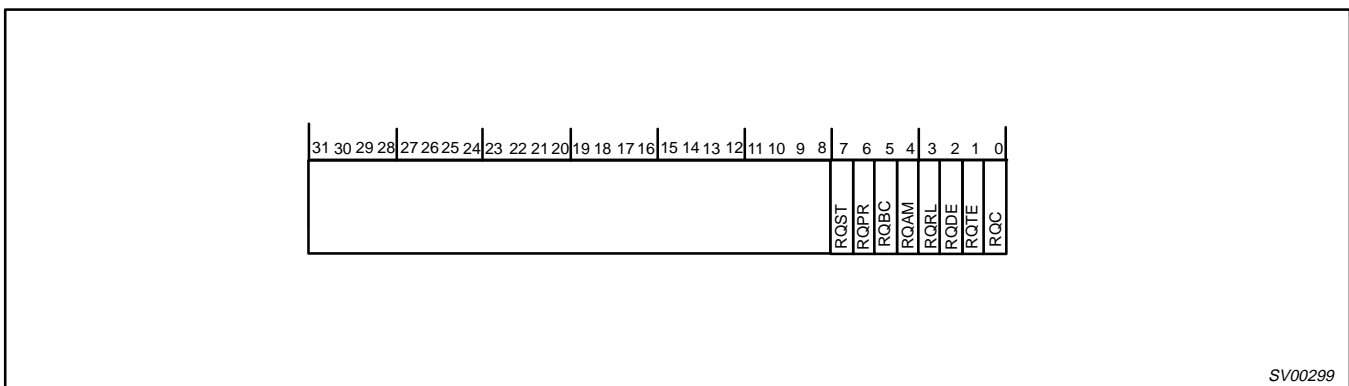

Reset Value 0x00000000

Bit 31..8: R Unused bits read '0'
 Bit 7: R RQST: request split time out
 Bit 6: R RQPR: request pending response received
 Bit 5: R RQBC: request broadcast sent
 Bit 4: R RQAM: request acknowledge missing
 Bit 3: R RQRL: request retry limit
 Bit 2: R RQDE: request data error

1394 AV link layer controller

PDI1394L11

Bit 1: R RQTE: request type error
 Bit 0: R RQC: request complete

13.3.10 Asynchronous Receive Response Status (RX_RPCF) – Base Address: 0x0A4

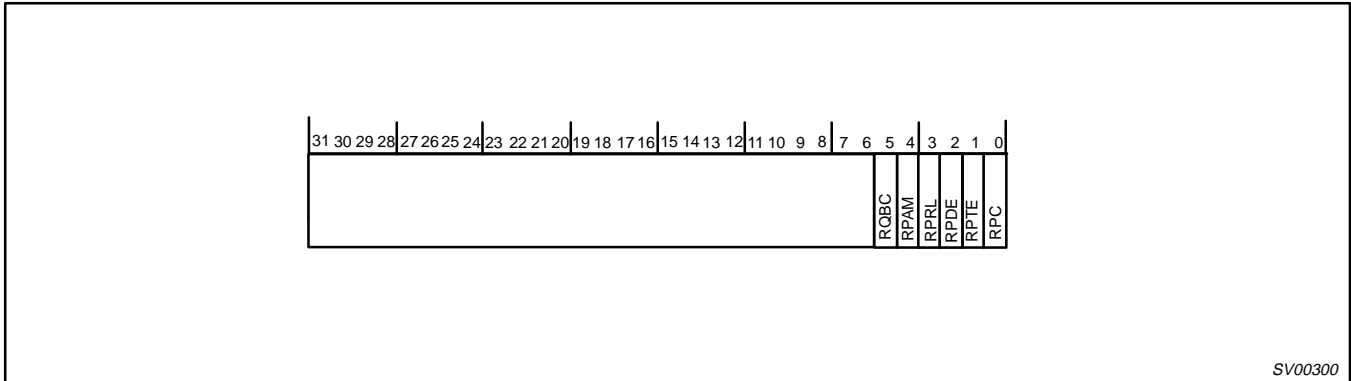

SV00300

Reset Value 0x00000000

Bit 31..65: R Unused bits read '0'
 Bit 5: R RPBC: response broadcast sent
 Bit 4: R RPAM: response acknowledge missing
 Bit 3: R RPRL: response retry limit
 Bit 2: R RPDE: response data error
 Bit 1: R RPTE: response type error
 Bit 0: R RPC: response complete

14.0 DC ELECTRICAL CHARACTERISTICS

SYMBOL	PARAMETER	TEST CONDITIONS	LIMITS			UNIT
			Temp = 0°C to +70°C			
			MIN	TYP	MAX	
V _{IK}	Input clamp voltage					V
V _{OH}	HIGH level input voltage					V
V _{OL}	LOW level input voltage					V
I _L	Input leakage current					μA
I _{OZL}	3-State output current					μA
I _{OZH}	3-State output current					μA
I _{DD}	Quiescent supply current					mA
ΔI _{DD}	Additional supply current per input pin					mA

1394 AV link layer controller

PDI1394L11

15.0 AC CHARACTERISTICS

GND = 0V, $t_R = t_F = 3.0\text{ns}$, $C_L = 50\text{pF}$, $R_L = 500\Omega$, $V_{CC} = 3.3\text{V}$

SYMBOL	PARAMETER	TEST CONDITIONS	WAVEFORMS	LIMITS			UNIT
				$T_{\text{amb}} = 0^\circ\text{C to } +70^\circ\text{C}$			
				MIN	TYP	MAX	
t_w	AV clock pulse			20	TBD		ns
t_{CLK}	AV clock period			40	TBD		ns
t_{SU}	AVDATA input setup time wrt AVCLK leading edge				3		ns
t_{ih}	AVDATA input hold time wrt AVCLK leading edge			3			ns
t_{oh}	Data output hold time			3	t_{od}		ns
t_{as}	Host interface address /CS_N setup time				3		ns
t_{ah}	Host interface address /CS_N hold time			108			ns
t_{ds}	Data write setup time						ns
t_{dsr}	Data read setup time			108			ns
t_{dz}	Data release						ns
wrwp	Write/Read pulse width			108			ns
t_{wdh}	Write data hold time			108			ns
t_{rdo}	Read data out			108			ns

16.0 TIMING DIAGRAMS

16.1 AV Interface Operation

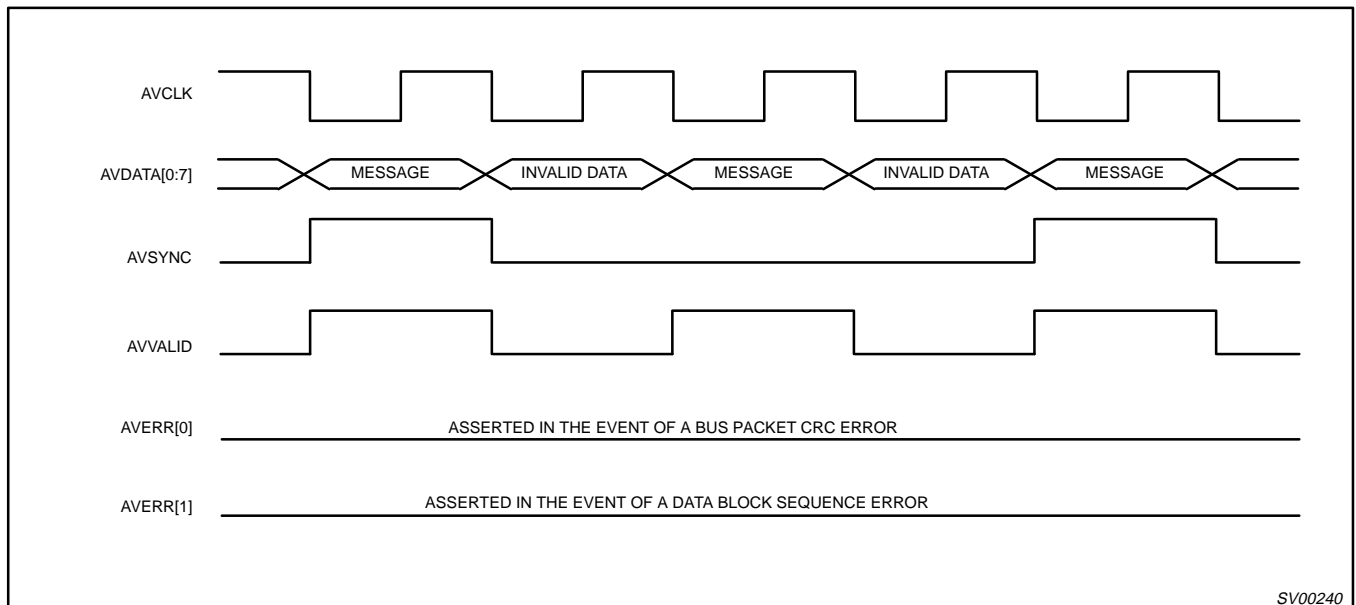

1394 AV link layer controller

PDI1394L11

16.2 AV Interface Critical Timings

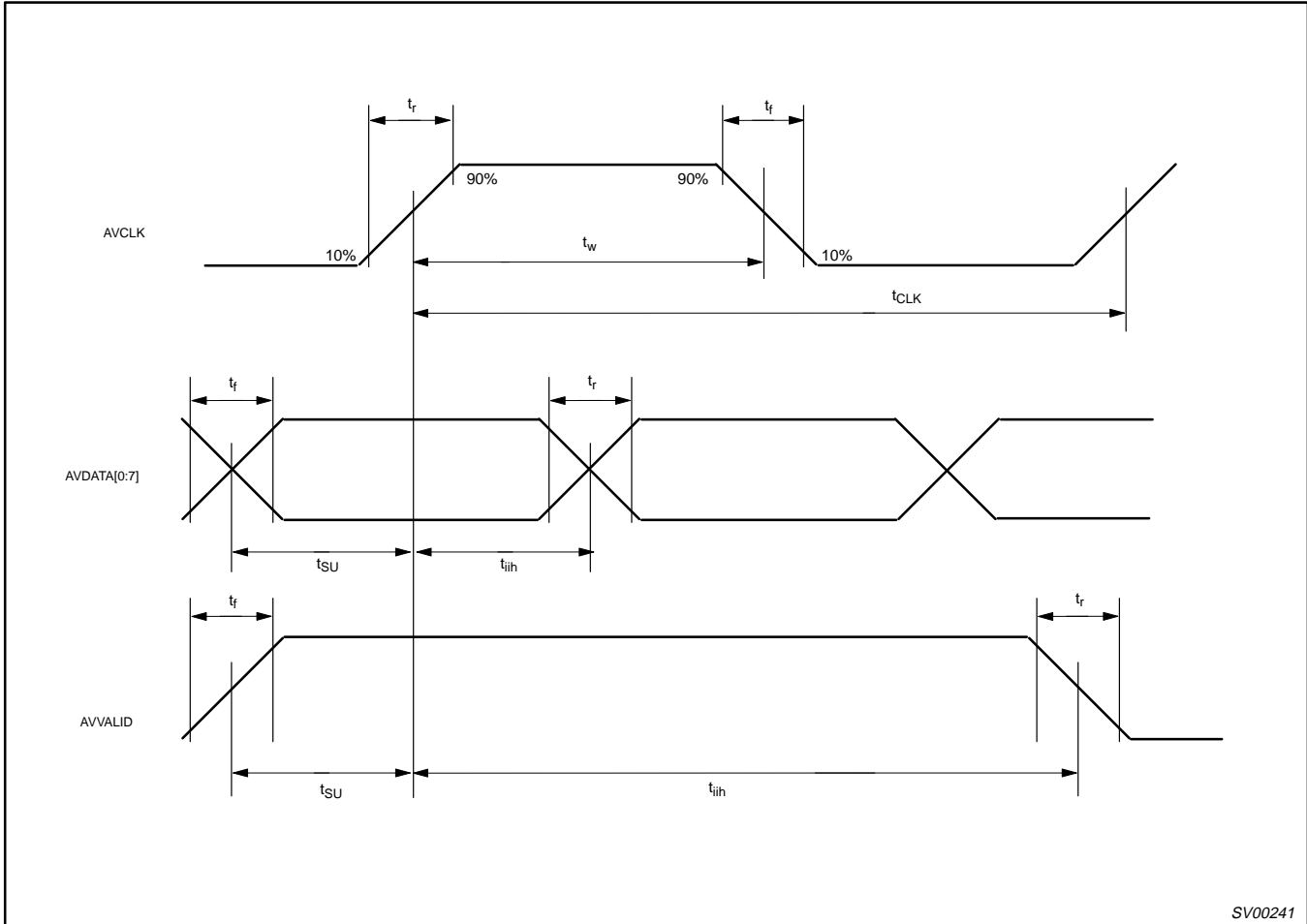

SV00241

1394 AV link layer controller

PDI1394L11

16.3 PHY-Link Interface Critical Timings

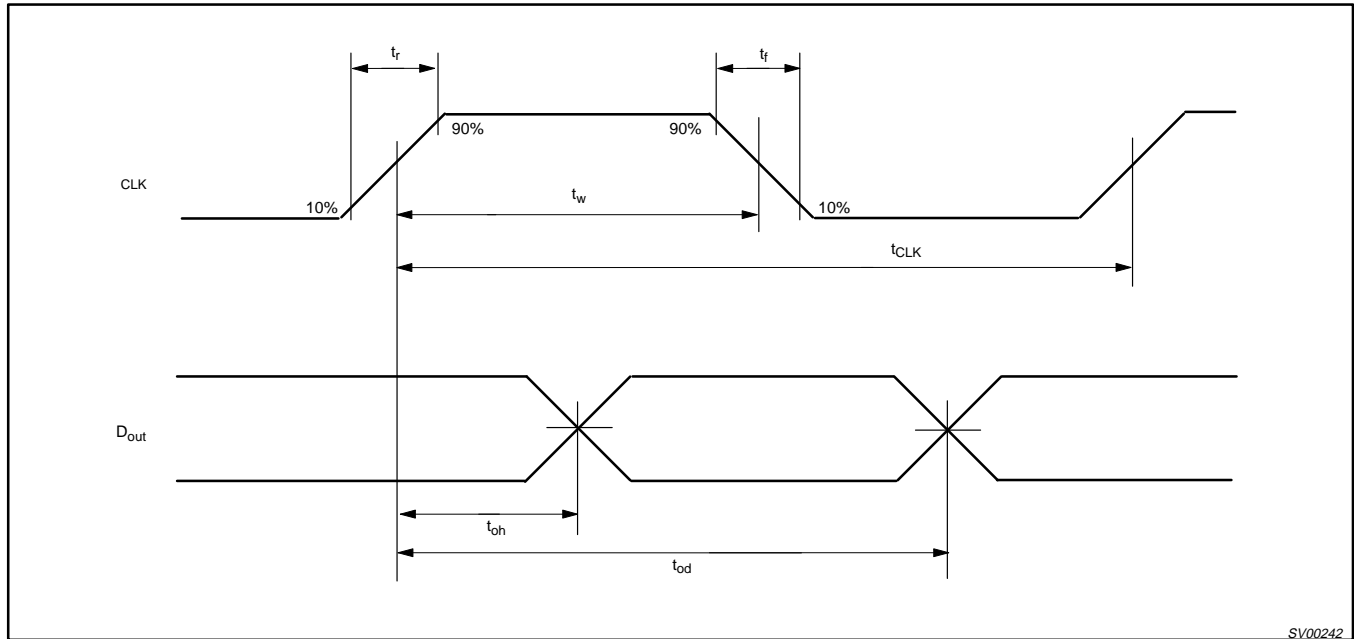

SV00242

16.4 Host Interface Critical Timings

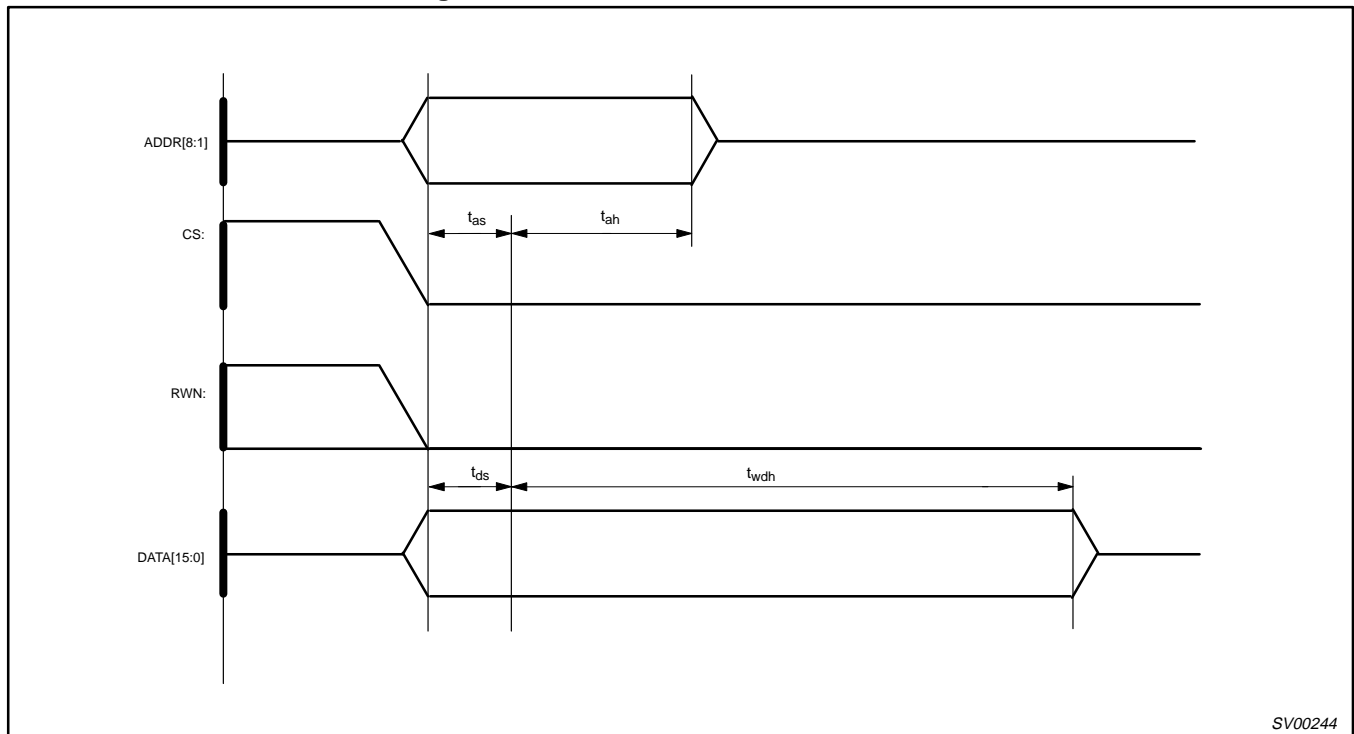

SV00244

Figure 19. Motorola Write Timing Non-multiplexed

1394 AV link layer controller

PDI1394L11

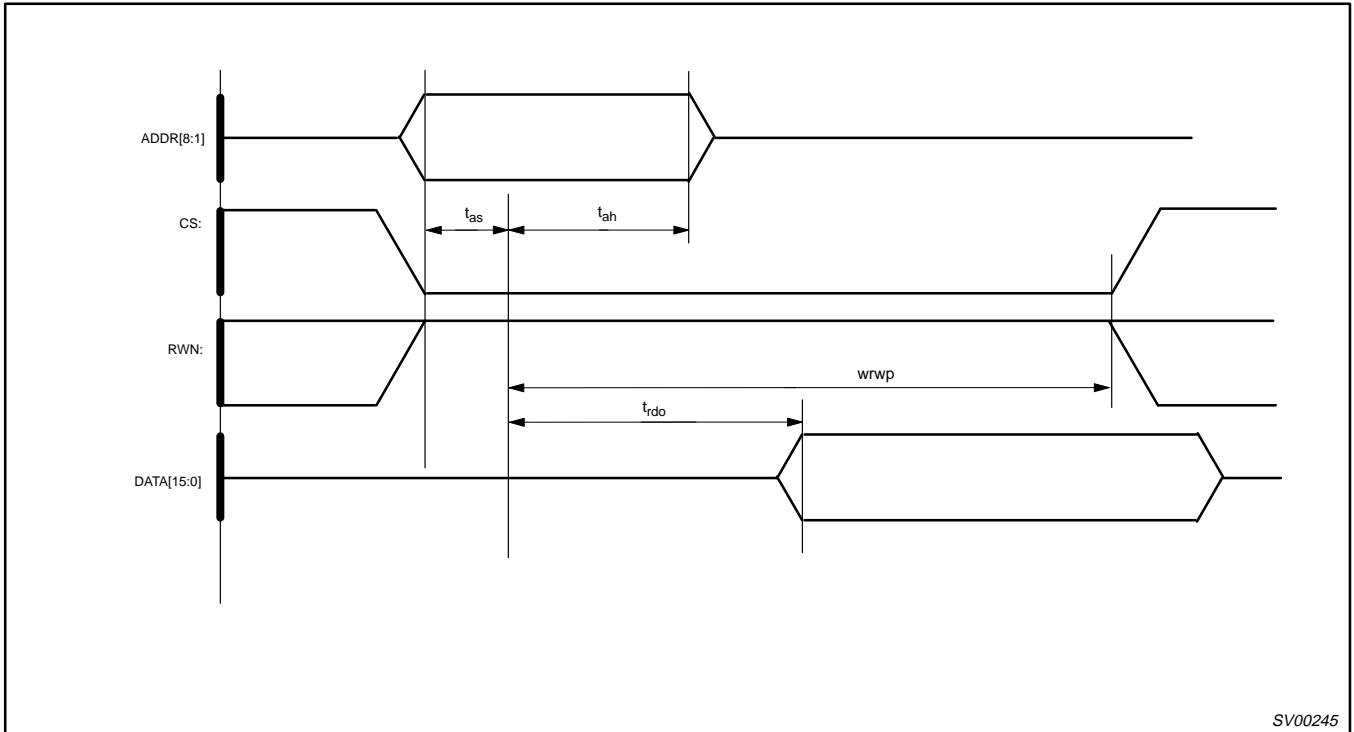

Figure 20. Motorola Read Timing Non-multiplexed

SV00245

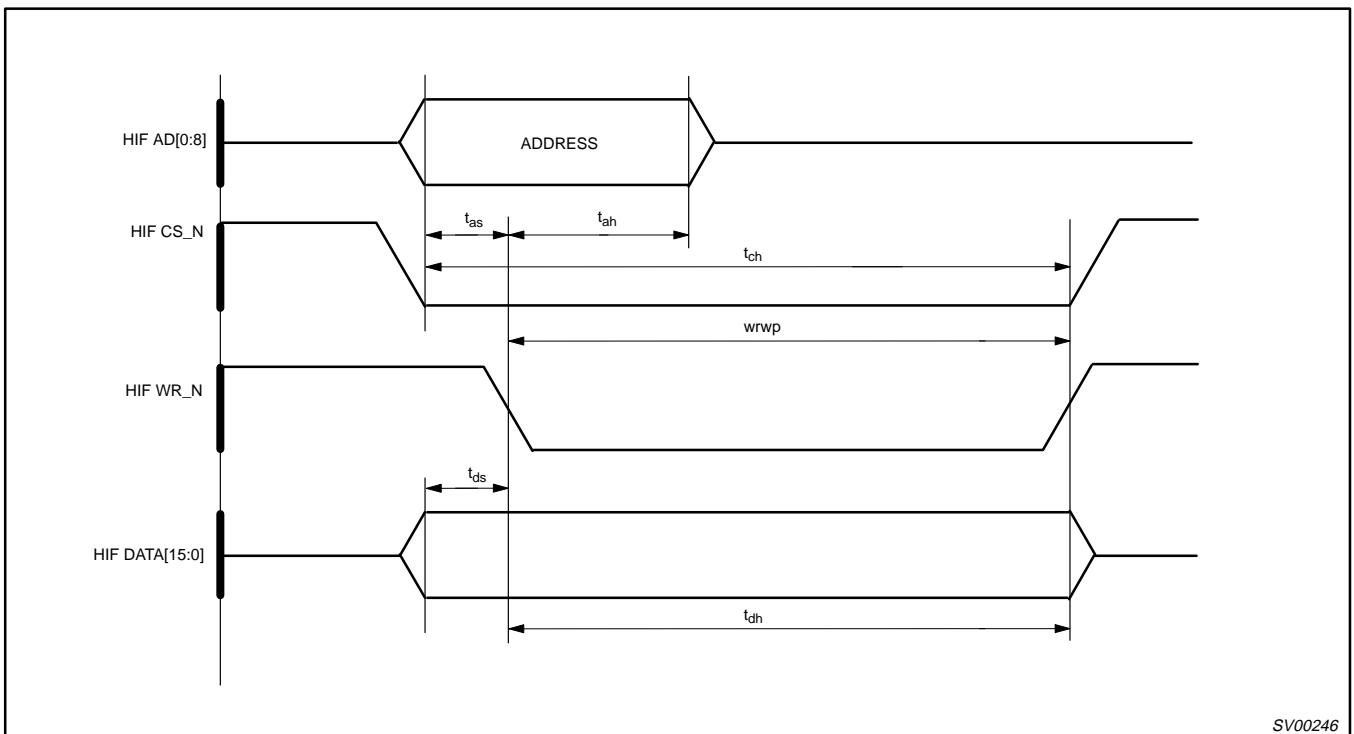

Figure 21. Intel Write Timing Non-multiplexed

SV00246

1394 AV link layer controller

PDI1394L11

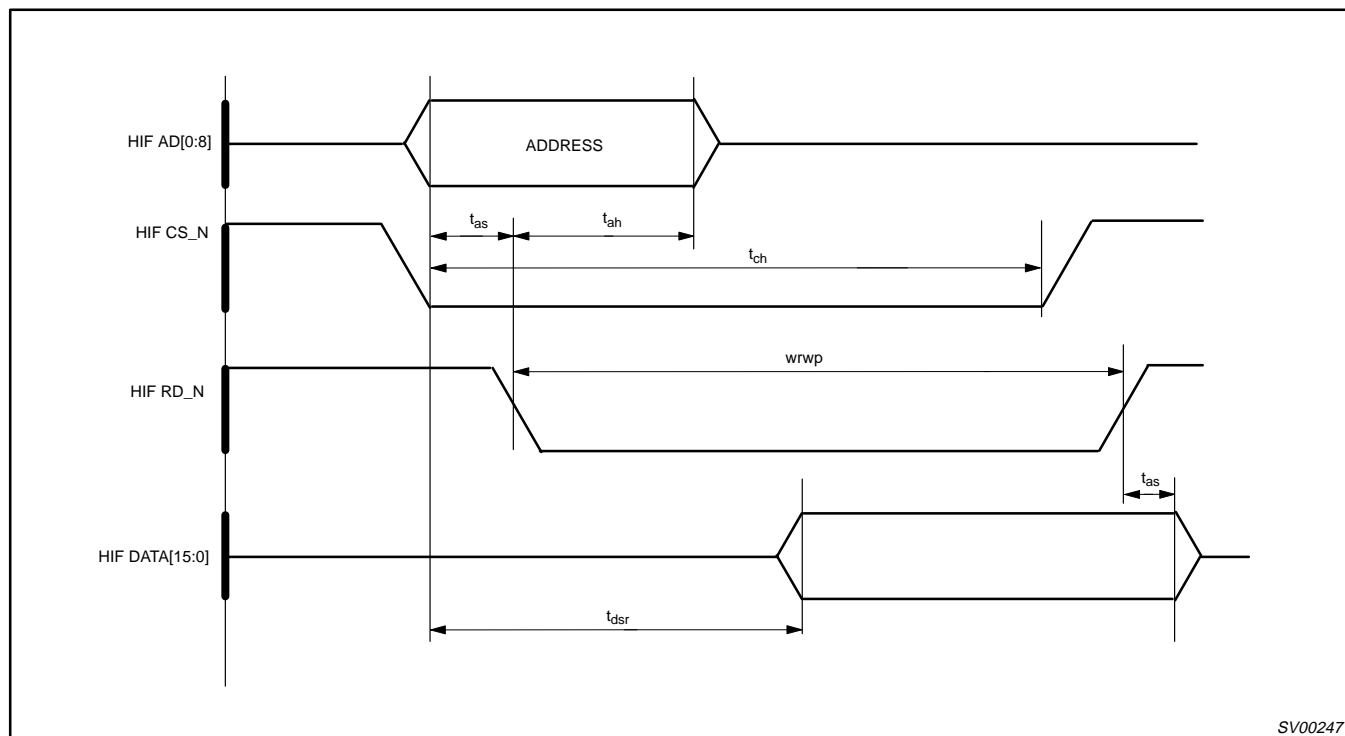

Figure 22. Intel Read Timing Non-multiplexed

1394 AV link layer controller

PDI1394L11

QFP80: plastic quad flat package; 80 leads (lead length 1.95 mm); body 14 x 20 x 2.8 mm

SOT318-2

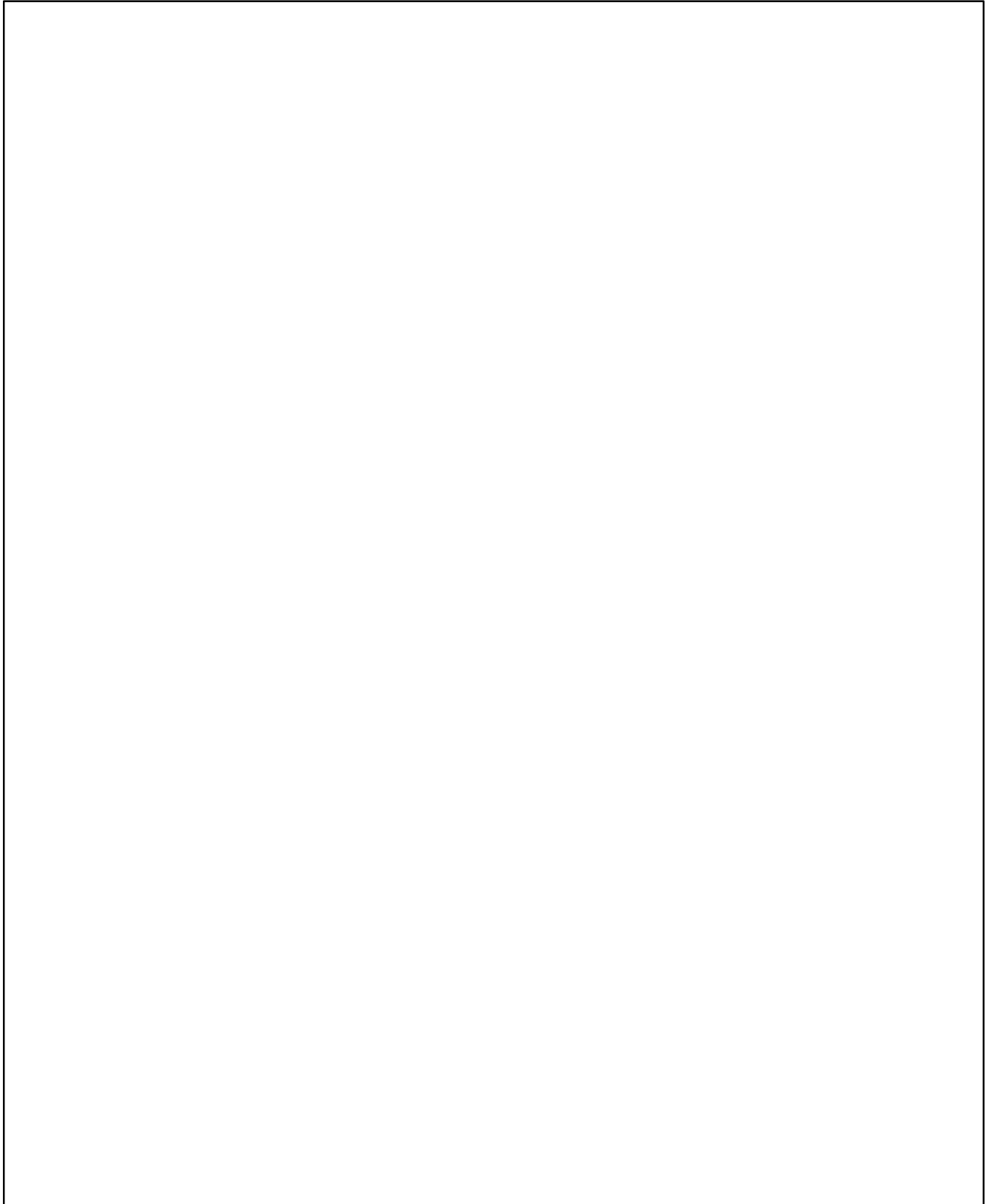

1394 AV link layer controller

PDI1394L11

DEFINITIONS

Data Sheet Identification	Product Status	Definition
<i>Objective Specification</i>	Formative or in Design	This data sheet contains the design target or goal specifications for product development. Specifications may change in any manner without notice.
<i>Preliminary Specification</i>	Preproduction Product	This data sheet contains preliminary data, and supplementary data will be published at a later date. Philips Semiconductors reserves the right to make changes at any time without notice in order to improve design and supply the best possible product.
<i>Product Specification</i>	Full Production	This data sheet contains Final Specifications. Philips Semiconductors reserves the right to make changes at any time without notice, in order to improve design and supply the best possible product.

Philips Semiconductors and Philips Electronics North America Corporation reserve the right to make changes, without notice, in the products, including circuits, standard cells, and/or software, described or contained herein in order to improve design and/or performance. Philips Semiconductors assumes no responsibility or liability for the use of any of these products, conveys no license or title under any patent, copyright, or mask work right to these products, and makes no representations or warranties that these products are free from patent, copyright, or mask work right infringement, unless otherwise specified. Applications that are described herein for any of these products are for illustrative purposes only. Philips Semiconductors makes no representation or warranty that such applications will be suitable for the specified use without further testing or modification.

LIFE SUPPORT APPLICATIONS

Philips Semiconductors and Philips Electronics North America Corporation Products are not designed for use in life support appliances, devices, or systems where malfunction of a Philips Semiconductors and Philips Electronics North America Corporation Product can reasonably be expected to result in a personal injury. Philips Semiconductors and Philips Electronics North America Corporation customers using or selling Philips Semiconductors and Philips Electronics North America Corporation Products for use in such applications do so at their own risk and agree to fully indemnify Philips Semiconductors and Philips Electronics North America Corporation for any damages resulting from such improper use or sale.

Philips Semiconductors
811 East Arques Avenue
P.O. Box 3409
Sunnyvale, California 94088-3409
Telephone 800-234-7381

Philips Semiconductors and Philips Electronics North America Corporation
register eligible circuits under the Semiconductor Chip Protection Act.
© Copyright Philips Electronics North America Corporation 1996
All rights reserved. Printed in U.S.A.

Date of release: 10-96

Document order number:

9397 750 01429